

Tualatin Hills Park & Recreation District

Athletic Facilities Functional Plan



Approved March 7, 2016

Tualatin Hills Park & Recreation District
Athletic Facilities Functional Plan

Board of Directors

Larry Pelatt, President
Jerry Jones Jr., Secretary
John Griffiths, Secretary Pro-Tempor
Ali Kavarianian, Director
Bob Scott, Director

THPRD Management Oversight

Doug Menke, General Manager
Aisha Panas, Director of Park & Recreation Services
Keith Hobson, Director of Business & Facilities

THPRD Project Team

Scott Brucker, Superintendent of Sports
Katherine Stokke, Operations Analyst
Julie Rocha, Athletic Center Supervisor
April Hammel, Program Coordinator
Brian Leahy, Tennis Center Supervisor
Troy Schader, Athletic Facilities Supervisor
Matt Kilmartin, Park Planner
Lindsay Beckman, Leadership Team Assistant

Consultant

Mark Fulop and Fatima Oswald, Facilitation & Process, LLC

Table of Contents

1. Executive Summary	5
Table 1: Athletic Facility Locations and Inventory	6
Figure 1: Population Trends	7
2. Introduction	11
3. Overview of the Functional Plan	11
4. Athletic Facility Use	12
Figure 2: THPRD Parks, Recreation Facilities, Maintained School Grounds & Natural Areas	13
5. Comprehensive Plan Needs	14
6. Athletic Facility Locations and Inventory	15
Table 2: Athletic Facility Locations and Inventory	15
Figure 3: THPRD Facilities and Complexes	16
Figure 4: THPRD Multipurpose Fields	17
Figure 5: THPRD Baseball/Softball Fields	18
Figure 6: THPRD Maintained Courts	19
Table 3: THPRD Athletic Facilities and Sites	20
7. Capacity, Use, and Demand	23
Figure 7: District Population and Affiliate Users	23
Figure 8: Hours Available, Usable, Desired and Used	24
Figure 9: Hours Used	25
Table 4: Affiliate Users and Affiliate Billable Hours Used by Sport	26
8. Future Conditions	27
9. Community Input on Facility Needs and Use	28
10. Meeting Future Athletic Facility Needs Cost Effectively	29
11. Future Athletic Facilities Through Land Acquisitions	29
12. Partnerships and Shared Use Intergovernmental Agreements	30
13. New and Repurposed Facilities	30
Figure 10: Howard M. Terpenning Recreation Complex	31
14. Athletic Facility Design, Layout Guidelines, and Materials	32
15. Lighting	32
16. Athletic Facility Amenities and Optional Structures	33
17. Department Involvement, Design, and Review	37
18. Athletic Facility Assignment Priorities, Tiered System	37
19. Maintenance Standards	38
20. Funding	41
Figure 11: Cost Recovery Pyramid Methodology	41
21. Measuring Our Results	43
22. Recommendations: 2015-2020	44
Table 5: Completed projects, 2008 Bond Measure	45
Figure 12: District Population and Affiliate Users	46
Figure 13: Hours Available, Usable, Desired and Used	46
Figure 14: Hours Used	47

Table 6: Affiliate Users and Affiliate Billable Hours Used by Sport	47
Glossary	52
Appendices	53
Layout Guidelines	
Figure 15: Baseball/Softball Dimensions	54
Figure 16: Soccer Field Dimensions	55
Figure 17: Lacrosse Field Dimensions	56
Figure 18: Football Field Dimensions	57
Figure 19: Rugby Field Dimensions	58
Figure 20: Tennis Court Dimensions	59
Figure 21: Pickleball Court Dimensions	60
Figure 22: Basketball Court Dimensions	61
Figure 23: Sand Volleyball Court Dimensions	62
Figure 24: Bocce Court Dimensions	63
Figure 25: Cricket Pitch Dimensions	64
Athletic Facility Profiles	
Figure 26: Synthetic Turf Profile	65
Figure 27: Sand-Base Sports Field	66
Figure 28: Native Field with Sub-surface Drainage	67
Figure 29: Skinned Clay Infield Detail	68
Figure 30: Asphalt Court Section with Acrylic Surfacing	69
Figure 31: Asphalt Court Section	70
Figure 32: Sand Volleyball Court Section	71
Figure 33: Bocce Court Profile	72
Reference Documents	73

1.0 Executive Summary

The purpose of this Athletic Facilities Functional Plan is to provide guidance for implementing athletic facility related goals identified in Tualatin Hills Park & Recreation District's (THPRD) 2013 Comprehensive Plan Update. Several goals identified how the district provides services. These goals set forth THPRD's approach to providing, developing, and maintaining services and athletic facilities for its patrons. The 2013 Comprehensive Plan Update identified the need for five functional plans: Parks, Programs, Natural Areas, Trails, and Athletic Facilities. The five plans are intended to work together in bringing services to the public in a coordinated fashion. As part of that coordinated effort, this plan will address the following areas:

1. Developing current inventory and use of district-owned and maintained athletic facilities
2. Projecting future use and demand
 - a. By sport, season, and location
3. Establishing design guidelines and service levels
 - a. By sport, season, and location
4. Developing an allocation model that:
 - a. Achieves maximum use of athletic facilities
 - b. Provides established service levels by sport, season, and location
 - c. Effectively communicates with the public and athletic facilities users

Through single and multiuse athletic facilities, THPRD engages a range of community members, community groups, and other entities that use the THPRD athletic facilities. These groups include the general public, THPRD programs, groups and organizations such as the Beaverton School District (BSD) and affiliated sports organizations. The athletic facilities are used for the following purposes: scheduled youth and adult sports programs, drop-in times/daily neighborhood activities, community events, family events, and concert and theater activities. Athletic facility reservations are determined through priority use – a tiered system with facility application fees and rental fees.

Current Conditions

THPRD is meeting the needs of the community as measured by the expressed demand for facilities. The demand is being met with excess capacity in some areas and on certain types of facilities.

- Peak demand is fall (August through November) and spring (March through June),
- THPRD has excess capacity on baseball/softball fields in general, and
- THPRD has excess capacity on all fields in the non-peak summer (July through August) and winter (November through February) months.

For the purpose of this functional plan, athletic facilities are inventoried by type and quadrant. Facilities may be sited on THPRD property and include sports complexes, parks, and special use facilities. They may also be located on property owned by another entity and governed by an

Intergovernmental Agreement (IGA) such as with BSD or the Tualatin Valley Water District (TVWD). Provided next is a summary of THPRD athletic facilities.

Table 1

Athletic Facility Locations and Inventory

Athletic Facility Type	Quadrant	Number of Fields
Multipurpose Fields	NE	31
	NW	46
	SE	40
	SW	27
	Total	144
Synthetic Turf Fields	NE	1
	NW	5
	SE	3
	SW	1
	Total	10
Baseball/Softball Fields	NE	40
	NW	15
	SE	28
	SW	22
	Total	105
Outdoor Tennis Courts	NE	32
	NW	35
	SE	24
	SW	13
	Total	104
Outdoor Basketball Courts	NE	11
	NW	14
	SE	17
	SW	7
	Total	49
Outdoor Pickleball Courts	NE	1
	NW	
	SE	1
	SW	
	Total	2

Athletic Facility Type	Quadrant	Number of Fields
Bocce	NE	3
	NW	
	SE	
	SW	
	Total	3
Skate Parks	NE	
	NW	2
	SE	1
	SW	
	Total	3
Sand Volleyball	NE	2
	NW	
	SE	
	SW	
	Total	2
Practice Cricket Pitch	NE	
	NW	1
	SE	
	SW	
	Total	1
Disc Golf	NE	
	NW	
	SE	1
	SW	
	Total	1
Bicycle Track	NE	
	NW	
	SE	1
	SW	
	Total	1

The current population of THPRD is 238,013 with 23,680 users for monitored or permitted athletic facilities; this use is predominately athletic fields. THPRD does not have use data for non-monitored or unpermitted athletic facilities such as disc golf, skate parks, tennis courts in parks, and basketball pads in parks.

Figure 1

Population Trends

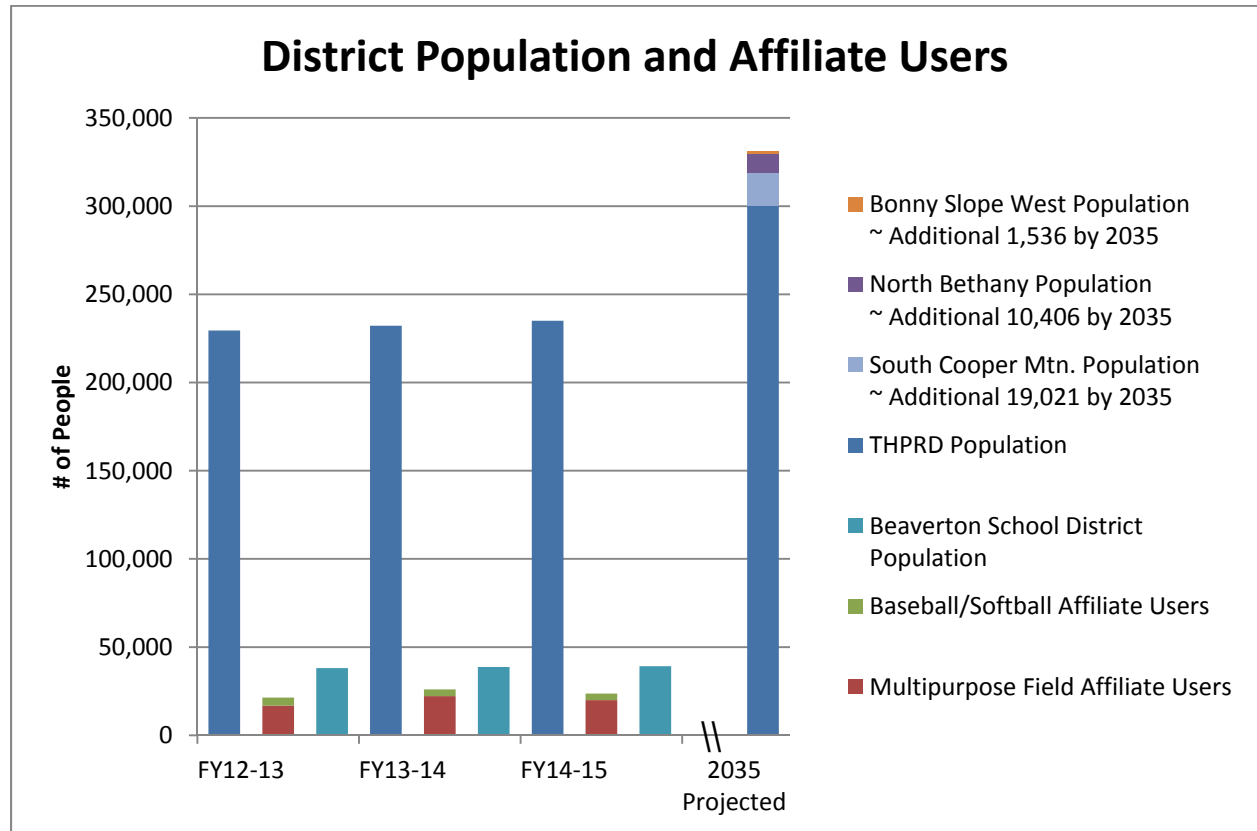

The population of THPRD is growing at an estimated rate of 1.2% annually. The growth of users is consistent with the growth trends of existing population centers and shows that THPRD is meeting the needs of the current population centers with capacity to continue meeting their needs. However, as new population centers such as the South Cooper Mountain planning area, the Bonny Slope planning area and, the North Bethany planning area are developed, athletic facility demand will need to be met based on proximity to these new population centers.

As future demand and needs are identified, an integral part of the athletic facility planning and development process will be the Access for All initiative. Despite progress in social attitudes, people with disabilities continue to experience stigma and exclusion, as well as social and economic marginalization. The need for inclusive, accessible programs and facilities for children and adults with disabilities far outpaces available services.

Based on population center development trends, and meeting current needs, the following recommendations have been developed.

Recommendations: General Action Steps

1. THPRD will continue to partner in development of and access to athletic facilities located in neighborhoods or near population centers when appropriate.
Examples include but are not limited to:
 - a. Location is in an identified area of demand for facilities
 - b. Location or facility meets a defined need
 - c. Location or facility provides a new service
2. THPRD will continue to evaluate and track the use of all athletic facilities.
Examples include but are not limited to:
 - a. Determine levels of use and identify efficiencies of assignment
 - b. Review assignment process to increase access for adults and non-traditional sports
 - c. Assist in identifying levels of demand or surplus capacity
 - d. Maintain the ratio of population to facility availability
 - e. Identify facilities that can be repurposed or moved to a lower level of service
3. THPRD will track the relationship of facility use fees and resulting changes in demand or use to assist with projecting future needs.
 - a. Increase use of targeted facilities to assist with improving cost recovery
4. THPRD will evaluate the permitted athletic facility assignment procedures.
 - a. Maximize use of synthetic turf fields
 - b. Maximize use of facilities with lights
 - c. Maximize use of athletic facility locations with multiple fields for efficiency
5. THPRD will consider how every decision or plan related to athletic facilities addresses Access for All goals or advances Access for All priorities.
6. THPRD will routinely check in with other community experts and partners to determine gaps in services.
 - a. Use this information to prioritize planning and the use of athletic facilities
 - b. Identify and evaluate opportunities to partner on athletic facilities and programs

Recommendations: Priority Action Steps

7. THPRD will develop a system of collecting and tracking the use of tennis courts, basketball courts, and other special use facilities, in parks or at non-monitored facilities.
 - a. Define the demand for, and determine the appropriate locations for repurposing or redevelopment of existing facilities to expand services in a cost effective manner
8. THPRD will complete planning and construct the balance of the athletic facilities identified in the 2008 funding measure.
 - a. NW quadrant multipurpose grass youth athletic field, TBD
 - b. SW quadrant multipurpose grass youth athletic field, Living Hope Church
9. THPRD will increase athletic facility allocation for non-mainstream sports.

Cricket is currently assigned one day a week at one location. The sport is in demand among an identified underserved ethnic population.

 - a. Assure that the double wide synthetic turf field at the SW quadrant Community Park can accommodate cricket play
 - b. Review scheduling practices to provide time for cricket at the PCC Rock Creek Recreation Facility in the NW quadrant
10. THPRD will continue to monitor and track all local, regional, and national sports and activity trends.
 - a. Identify underserved population needs related to athletic facilities
 - b. Identify non-mainstream sports facility demand
 - c. Identify trends that require advance planning to develop, repurpose, or redevelop athletic facilities
 - d. Identify opportunities to increase use, or add new uses, of athletic facilities
11. THPRD will address growth in the North Bethany planning area (NE quadrant).

The North Bethany planning area is growing at a faster rate than was previously anticipated. This planning area is estimated to see a population growth of 10,721 residents and 5,000 housing units in the next 20 years.

 - a. Identify and execute partnerships to provide two baseball and softball fields that provide 3,954 hours of available time and two youth multipurpose grass athletic fields that provide 3,658 hours of multipurpose athletic field capacity.
 - b. Develop full sized athletic field or fields on THPRD property that will yield 5,096 hours of multipurpose athletic field capacity.
 - c. Develop one youth multipurpose grass athletic field on THPRD property that will yield 1,829 hours of multipurpose athletic field capacity.

- d. Provide space in all new park developments for athletic facilities and amenities through the planning process. These include but are not limited to: tennis, volleyball, basketball, and casual use.
- e. Consider assuming operations of the Springville K-8 multipurpose grass youth athletic field.

12. THPRD will address planned growth in the South Cooper Mountain planning area (SW quadrant).

The South Cooper Mountain planning area is in the initial stages of development with an estimated population of 19,021 and between 2,900 and 3,530 housing units by 2035. Additionally, BSD is adjusting boundaries to shift the student population south to make room at schools in the NW quadrant. This provides a cost-effective partnering opportunity to co-develop athletic facilities.

- a. Identify and execute partnerships that will provide one youth baseball and softball field, 1,977 hours; one youth multipurpose grass athletic field, 1,829 hours; a full sized athletic field or fields that can provide 3,954 hours of multipurpose athletic field capacity; and a minimum of four tennis courts.
- b. Provide space in all new park developments for athletic facilities and amenities through the planning process. These include but are not limited to: tennis, volleyball, basketball, and casual use.

2.0 Introduction

This Athletic Facilities Functional Plan addresses how THPRD develops, prioritizes, maintains, and evaluates athletic facilities within the district. THPRD manages 259 playing fields, 110 tennis courts, 116 basketball half-courts, bocce, skate parks, and special use facilities. THPRD owns athletic facilities as well as operates many athletic facilities owned by BSD or other entities. Some facilities are dedicated to single uses, while others are multiuse facilities used for various sports at different times of the year; this includes swimming pools and recreation centers. The purpose of this Athletic Facilities Functional Plan is to provide guidance for implementing athletic facility-related goals identified in THPRD's 2013 Strategic Plan and Comprehensive Plan Update. The functional plan will outline how THPRD:

- Assigns and utilizes district-owned and managed athletic facilities,
- Develops new or re-develops existing district-owned and managed athletic facilities, and
- Designs, constructs, and maintains district-owned and managed athletic facilities.

This plan is based on recent reports, technical data, and a wealth of experiential knowledge developed over decades of developing, maintaining, and promoting the use of athletic facilities across the greater Beaverton community.

3.0 Overview of the Functional Plan

Several goals identified in THPRD's 2013 Strategic Plan and Comprehensive Plan Update relate to how the district provides services. The need to develop functional plans in five key service delivery areas was identified to coordinate the efforts. The five functional plans are Parks, Programs, Natural Areas, Trails, and Athletic Facilities. The goals and functional plans set forth THPRD's approach to providing, developing, and maintaining services and athletic facilities for its patrons. To assist in meeting these goals, this plan will address the following areas:

1. Developing current inventory and use of district-owned and maintained athletic facilities
2. Projecting future use and demand
 - a. By sport, season, and location
3. Establishing design guidelines and service levels
 - a. By sport, season, and location
4. Refining an allocation model that:
 - a. Achieves maximum use of athletic facilities
 - b. Provides athletic facilities for underserved or emerging sports
 - c. Effectively communicates with the public and athletic facilities users

4.0 Athletic Facility Use

THPRD continually strives to meet the recreational needs of its diverse community. We do so in a customer-centered environment with the ultimate goal of supporting healthy lifestyles. Through single and multiuse athletic facilities, THPRD engages a range of community members, community groups, and other entities that use THPRD athletic facilities. These groups include the general public, THPRD programs, groups and organizations such as the BSD, and affiliated sports organizations. Athletic facilities are used for the following purposes: scheduled youth and adult sports programs, drop-in times/daily neighborhood activities, community events, family events, and concert and theater activities. Athletic facility reservations are determined through priority use – a tiered system with facility application fees and rental fees. (For additional details on priority use, reference section 18, page 37 of this document.)



The following map of THPRD Parks, Recreation Facilities, Maintained School Grounds, and Natural Areas (Figure 2) shows the scope of the district athletic facilities, parks, trails, natural areas, and recreational facilities. By focusing on a balanced approach to maximizing services across our district, our goal is to ensure that THPRD achieves its mission to provide high quality parks and recreation facilities, programs, services, and natural areas that meet the needs of the diverse communities we serve.



TUALATIN HILLS PARK & RECREATION DISTRICT

Parks, Recreation Facilities, Maintained School Grounds & Natural Areas

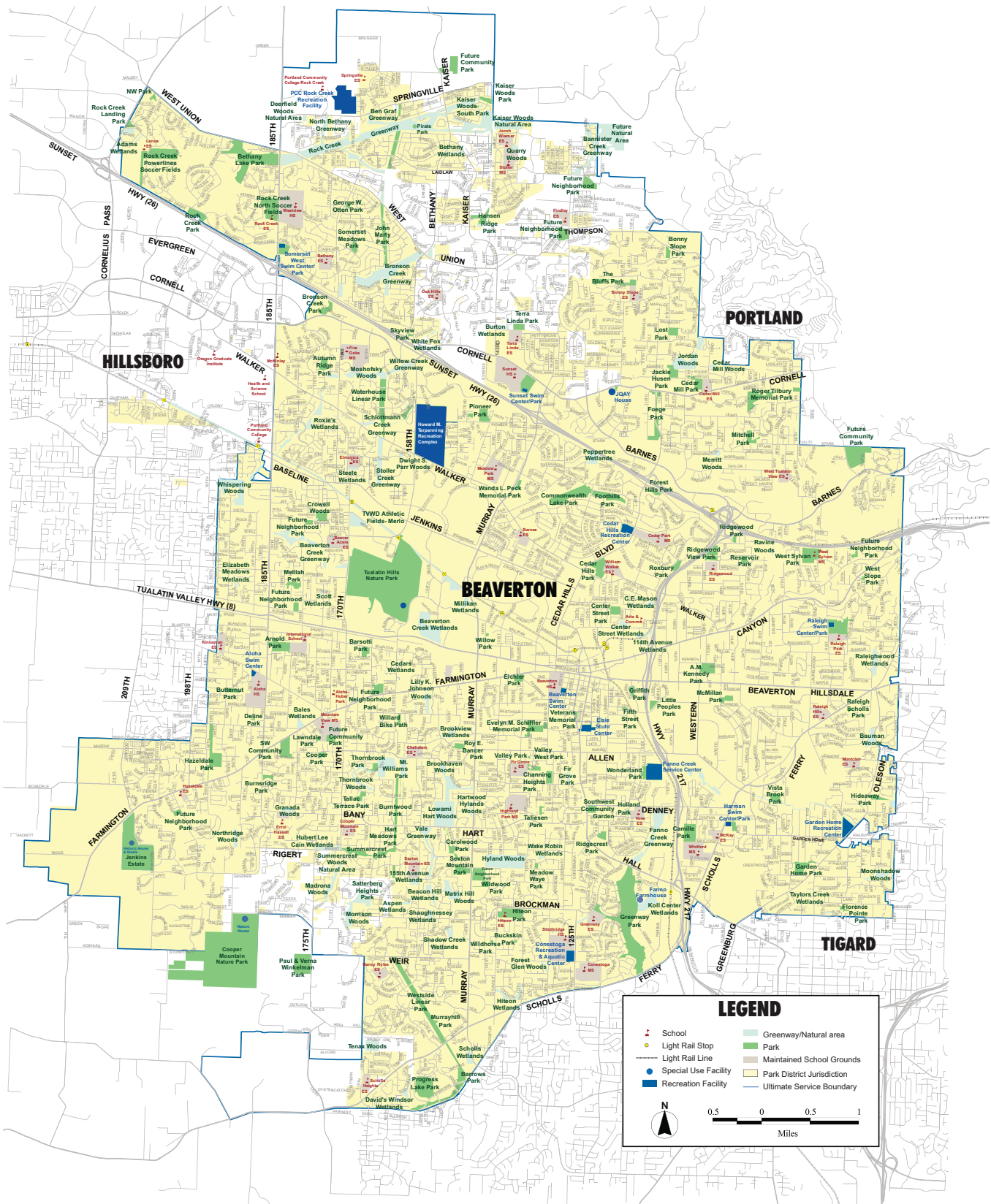

5.0 Comprehensive Plan Needs

The initial 2006 THPRD Comprehensive Plan was a guiding document that included goals, visions, and level of service recommendations to meet the parks and recreation needs of the district for five years. The 2013 THPRD Comprehensive Plan Update built upon that initial plan. The district has developed five functional plans (Parks, Programs, Natural Areas, Trails, and Athletic Facilities) to guide the implementation of the 2013 Comprehensive Plan Update and accomplish the goals set forth in it.

The 2013 plan update addresses athletic facilities with *Goal 2: Provide quality sports and recreation facilities and programs for park district residents and workers of all ages, cultural backgrounds, abilities, and income levels.*

The recommendation to accomplish Goal 2 is:
Conduct a field hour capacity analysis for peak times. Compare what is scheduled to what is actually used. ... Prioritize usage and convert high-use, district-owned fields into synthetic turf and/or lighted fields where an opportunity or demand exists. (Reference pages 75 and 82, Tualatin Hills Park & Recreation District Comprehensive Plan Update, July 2013)

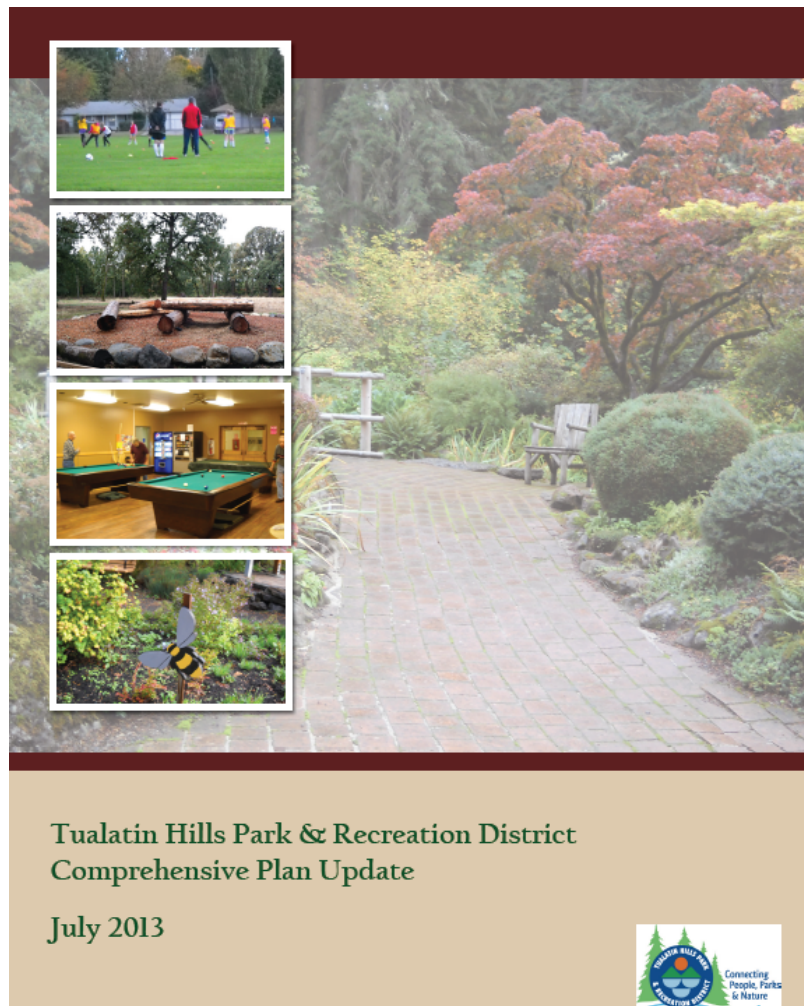

6.0 Athletic Facility Locations and Inventory

THPRD’s existing athletic facility types and locations were determined by the 2013 Comprehensive Plan Update. They were added to the inventory through public partnerships and opportunities for development. THPRD divides its service area into four quadrants (NE, NW, SE, and SW) and maintains athletic facilities in each.

THPRD’s current inventory of athletic facilities is summarized in the table below and represented graphically on the following four maps that delineate facilities by type. The athletic facilities and sites table follows the series of facilities maps.

Table 2

Athletic Facility Locations and Inventory

Athletic Facility Type	Quadrant	Count
Multipurpose Fields	NE	31
	NW	46
	SE	40
	SW	27
	Total	144
Synthetic Turf Fields	NE	1
	NW	5
	SE	3
	SW	1
	Total	10
Baseball/Softball Fields	NE	40
	NW	15
	SE	28
	SW	22
	Total	105
Outdoor Tennis Courts	NE	32
	NW	35
	SE	24
	SW	13
	Total	104
Outdoor Basketball Courts	NE	11
	NW	14
	SE	17
	SW	7
	Total	49
Outdoor Pickleball Courts	NE	1
	NW	
	SE	1
	SW	
	Total	2

Athletic Facility Type	Quadrant	Count
Bocce	NE	3
	NW	
	SE	
	SW	
	Total	3
Skate Parks	NE	
	NW	2
	SE	1
	SW	
	Total	3
Sand Volleyball	NE	2
	NW	
	SE	
	SW	
	Total	2
Practice Cricket Pitch	NE	
	NW	1
	SE	
	SW	
	Total	1
Disc Golf	NE	
	NW	
	SE	1
	SW	
	Total	1
Bicycle Track	NE	
	NW	
	SE	1
	SW	
	Total	1

Figure 3

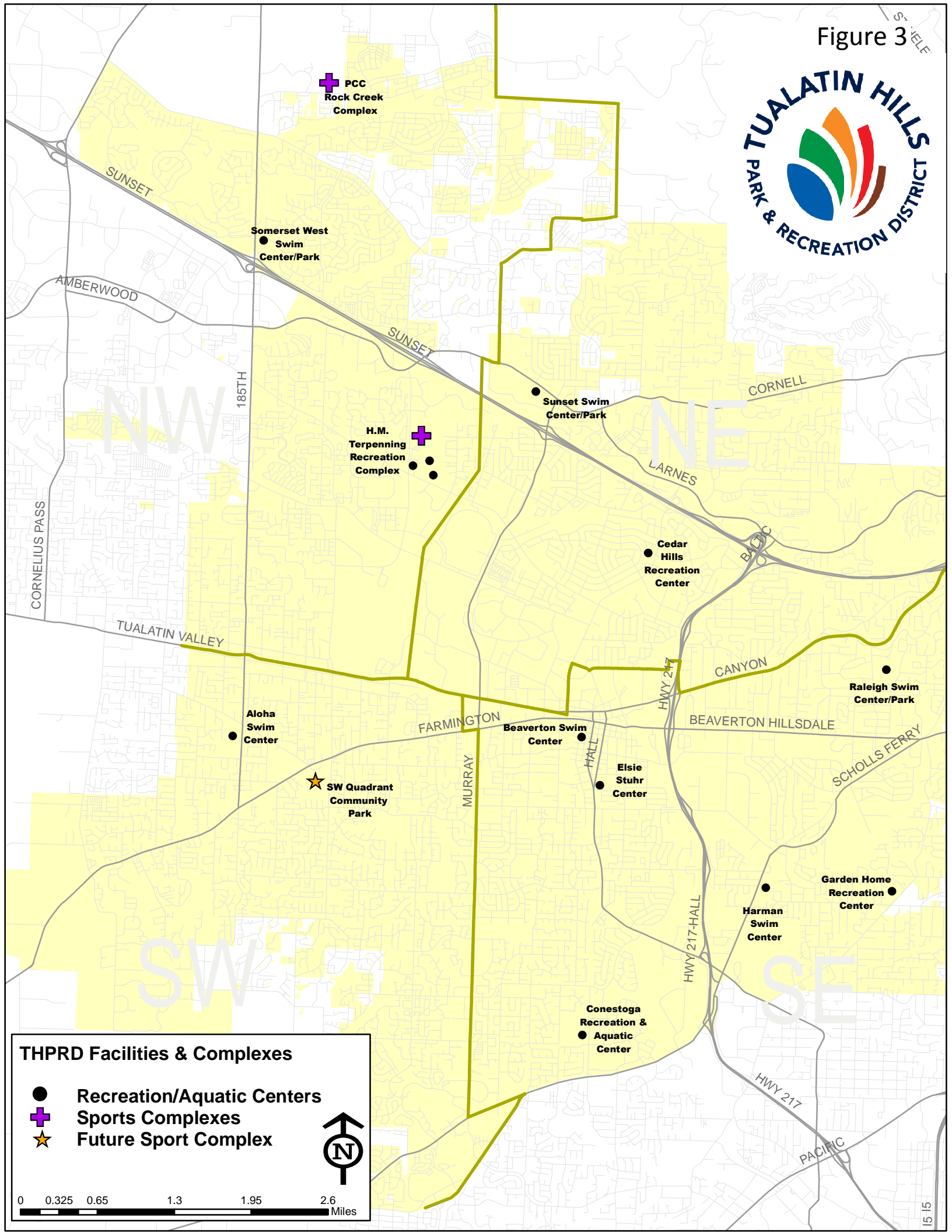

THPRD Facilities & Complexes

- Recreation/Aquatic Centers
- ✚ Sports Complexes
- ★ Future Sport Complex

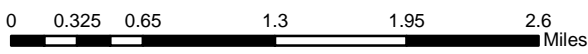
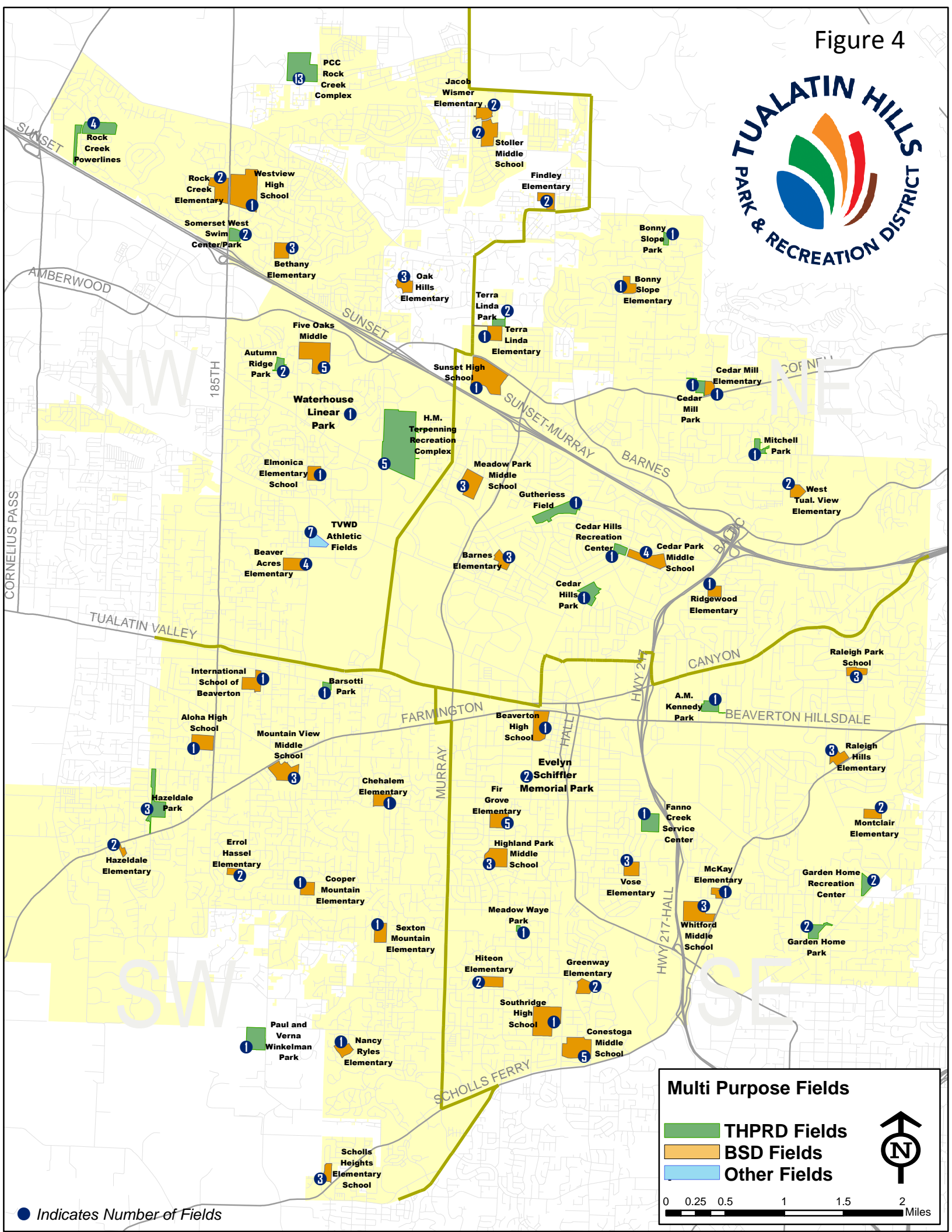



Figure 4



Multi Purpose Fields

- THPRD Fields
- BSD Fields
- Other Fields

0 0.25 0.5 1 1.5 2 Miles

● Indicates Number of Fields

Figure 5

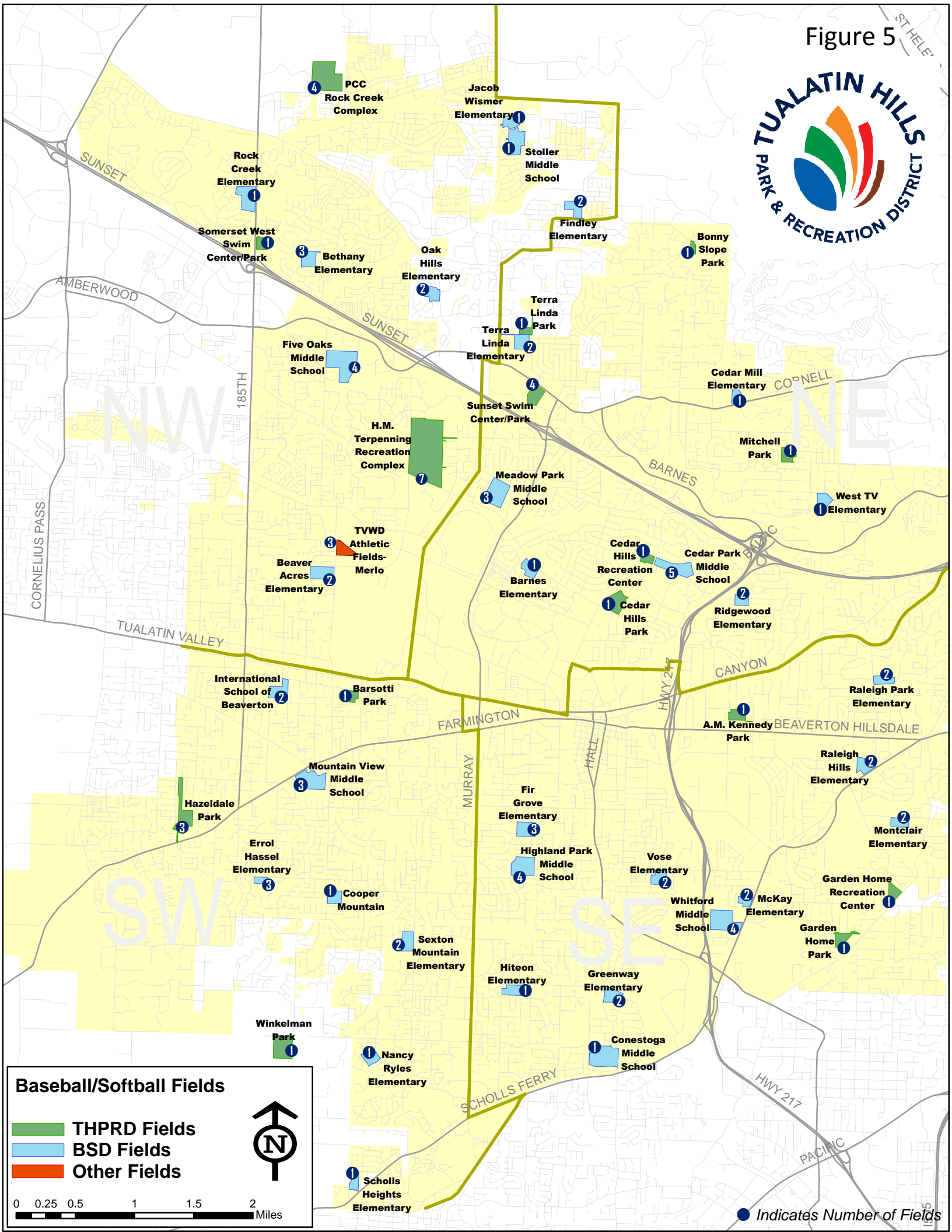

Baseball/Softball Fields

- THPRD Fields
- BSD Fields
- Other Fields

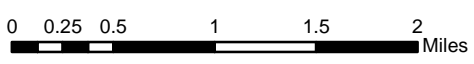

● Indicates Number of Fields

Figure 6

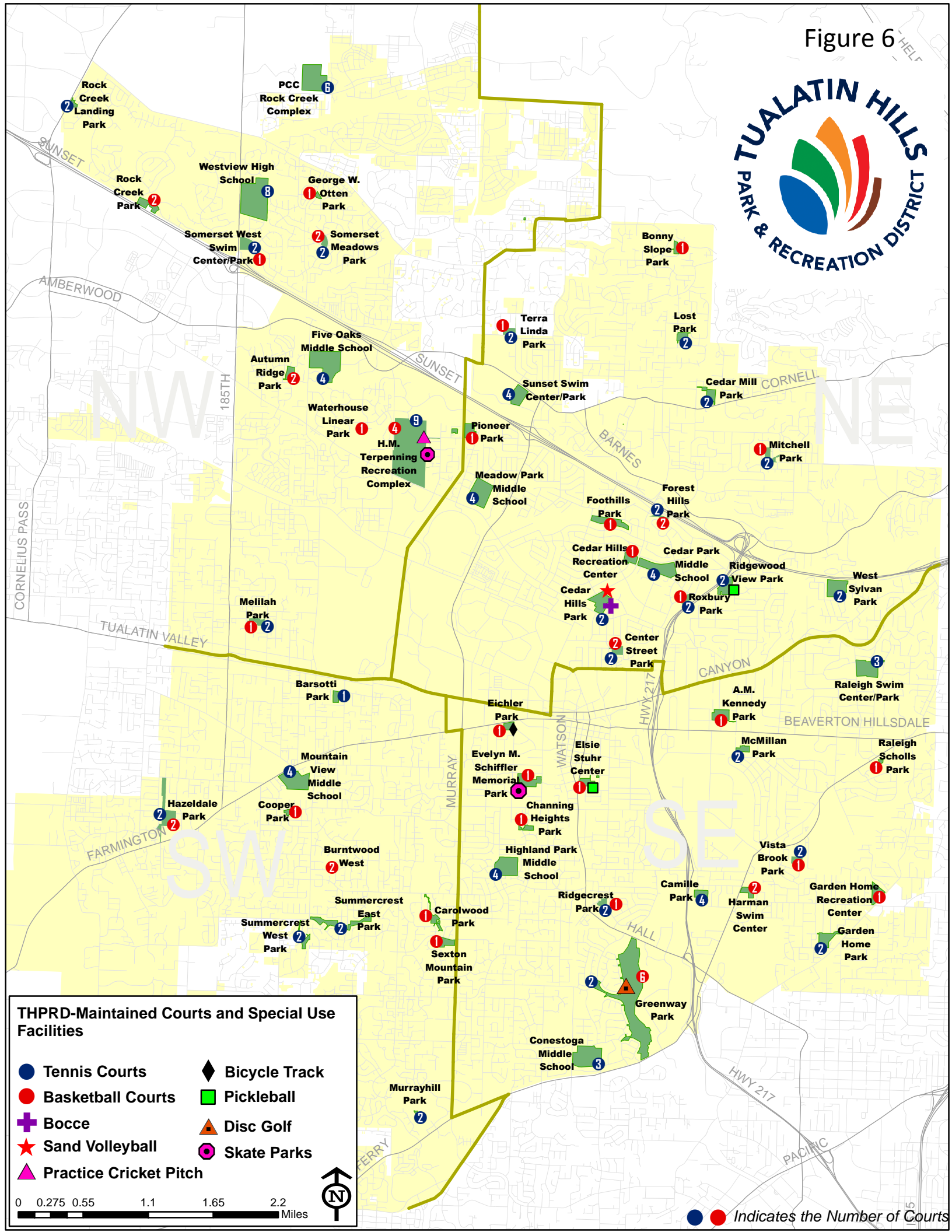

THPRD-Maintained Courts and Special Use Facilities

Tennis Courts	Bicycle Track
Basketball Courts	Pickleball
Bocce	Disc Golf
Sand Volleyball	Skate Parks
Practice Cricket Pitch	

0 0.275 0.55 1.1 1.65 2.2 Miles

Indicates the Number of Courts

THPRD Athletic Facilities and Sites

💡 - denotes lights
 IR - Irrigation
 QC - Quick Coupler
 DF - Drinking Fountain

	Quadrant	Multipurpose Turf Fields	Multipurpose Grass Fields	Baseball & Softball Fields	Tennis Courts	Basketball Courts	Outdoor Pools	Amenities								
								Parking Lot Capacity	Restrooms			Concessions	Water			Other
									Perm.	Portable Seas.	Yr-Round		IR	QC	DF	
Sports Complexes																
Portland Community College (PCC) - Rock Creek	NW	2💡	11💡	4💡	6💡			240	2		1	1	X	X	X	Maintenance Yard
H.M. Terpenning Complex	NW	2💡	3💡	7💡	9💡	4		360	2	7	4	1	X	X	X	Cricket Pitch 2 Skate Parks
Mt. View Middle School *Future Site	SW		3	3												

Parks																
A.M. Kennedy Park	SE		1	1		1		On Street			1		X	X	X	
Autumn Ridge Park	NW		2			2				1			X	X	X	
Barsotti Park	SW		1	1	1 * youth court			15		1			X	X	X	
Bonny Slope Park	NE		1	1		1					1		X	X	X	
Burntwood Park	SW					2					1		X	X	X	
Camille Park	SE				4						1		X	X	X	
Carolwood Park	SW					1							X	X	X	
Cedar Hills Park	NE		1	1	2💡			30			1		X	X	X	2 Sand volleyball 3 Bocce
Cedar Hills Recreation Center	NE		1	1		1				1			X	X	?	
Cedar Mill Park	NE		1		2					1			X	X	X	
Center Street Park	NE				2	2							X	X	X	
Channing Heights Park	SE					1							X	X	X	
Cooper Park	SW					1							X	X	X	
Eichler Park	SE					1				1			X	X	?	Bicycle Track
Elsie Stuhr Center	SE					1							X	X	?	Pickle Ball
Evelyn Schiffler Memorial Park	SE		2			1					2		X	X	X	
Fanno Creek Service Center	SE	1💡											X	X	X	
Foothills Park	NE					1					1		X	?	?	
Forest Hills Park	NE				2	2							X	X	X	
Garden Home Park	SE		2	1	2						1		X	X	X	
Garden Home Recreation Center	SE		2	1		1				1			X	X	X	
George Otten Park	NW					1							X	X	X	
Greenway Park	SE				2	6					1		X	X	X	
Gutherless Field	NE		1										X	X	?	
Harman Swim Center/Park	SE					2							X	X	?	
Hazeldale / Rosa Park	SW		3	3	2	2				2			X	X	X	
Jackie Husen Park	NE										1		X	X	X	
Lost Park	NE				2									X	?	
McMillan Park	SE				2								X	X	X	

THPRD Athletic Facilities and Sites

💡 - denotes lights
 IR - Irrigation
 QC - Quick Coupler
 DF - Drinking Fountain

	Quadrant	Multipupose Turf Fields	Multipurpose Grass Fields	Baseball & Softball Fields	Tennis Courts	Basketball Courts	Outdoor Pools	Amenities								
								Parking Lot Capacity	Restrooms			Concessions	Water			Other
									Perm.	Portable Seas.	Yr-Round		IR	QC	DF	
Meadow Way Park	SE		1						1			X	X	X		
Melilah Park	NW				2	1						X	X	X		
Mitchell Park	NE		1	1	2	1			1			X	X	X		
Murrayhill Park	SW				2					1		X	X	?		
Pioneer Park	NE					1						X	X	X		
Raleigh Scholls Park	SE					1										
Raleigh Swim Center/Park	SE				3					1		X	X	X		
Ridgecrest Park	SE				2	1						X	X	X		
Ridgewood View Park	NE				3											
Rock Creek Landing Park	NW				2							X	X	X		
Rock Creek Park	NW					2							X	X		
Rock Creek Powerline Park	NW		4				65		4	1		X	X	X		
Roxbury Park	NE				2	1						X	X	X		
Sexton MT. Park	SW					1						X		X		
Somerset Meadows Park	NW		2		2	2			1			X	X	X		
Somerset West Swim Center	NW		2	1	2	1	15		1			X	X	X		
Summercrest Park East	SW				2											
Summercrest Park West	SW				2											
Sunset Swim Center/Park	NE			4💡	4		75		2			X	X	X		
Terra Linda Park	NE		2	1	2	1						X	X	X		
TVWD Athletic Fields	NW		7	3			50		3			X	X	X		
Vista Brook Park	SE				2	1				1		X	X	X		
Waterhouse Powerline Park			1			1			1			X	X			
West Sylvan School (PPS)	NE				2				1				X			
Winkelman Park	SW		1	1						1		X	X	X		

BSD Properties															
Elementary Schools															
Barnes	NE		3	1						1			X	X	
Beaver Acres	SW		4	2						1				X	
Bethany	NW		3	3						1					
Bonny Slope	NE		1							1			X	X	
Cedar Mill	NE		1	1						1			X	X	X
Chehalem	SW		4	1						1				X	

Table 3

THPRD Athletic Facilities and Sites

💡 - denotes lights
 IR - Irrigation
 QC - Quick Coupler
 DF - Drinking Fountain

	Quadrant	Multipurpose Turf Fields	Multipurpose Grass Fields	Baseball & Softball Fields	Tennis Courts	Basketball Courts	Outdoor Pools	Amenities							
								Parking Lot Capacity	Restrooms		Concessions	Water			Other
									Perm.	Portable Seas.		Yr-Round	IR	QC	
Cooper Mountain	SW		1	1						1		X	X		
Elmonica	NW		1	1								X	X		
Errol Hassell	SW		2	3						1			X		
Findley	NE		2	2						1					
Fir Grove	SE		5	3						1		X	X		
Greenway	SE		2	2						1		X	X		
Hazeldale	SW		2	1						1					
Hiteon	SE		2	1						1		X	X		
Jacob Wismer	NE		2	1						1		X	X		
McKay	SE		1	2						1					
Montclair	SE		2	2						1					
Nancy Ryles	SW		1	1						1		X	X		
Oak Hills	NW		3	2						1			X		
Raleigh Hills (K-8)	SE		3	2						1			X		
Raleigh Park	SE		3	2							1		X		
Ridgewood	NE		1	2						1		X	X		
Rock Creek	NW		2	1						1		X	X		
Scholls Heights	SW		3	1						1		X	X		
Sexton Mountain	SW		1	2						1		X	X	X	
Terra Linda	NE		1	2						1			X		
Vose	SE		3	2						1					
West Tualatin View	NE		2	1						1					
William Walker	NE			1											
Middle Schools															
Cedar Park	NE		4	5	4					2			X	X	
Conestoga	SE		5	1	3					2			X	X	
Five Oaks	NW		5	4	4					2			X	X	
Highland Park	SE		3	4	4					2			X	X	
ISB (Option School)	SW		1	2💡						1			X	X	X
Meadow Park	NE		3	3	4					2			X	X	
Stoller	NE		3	1							1		X	X	
Whitford	SE		3	4						2			X		
High Schools															
Aloha	SW	1💡									1				
Beaverton	SE	1💡									1				
Southridge	SE	1💡									1				
Sunset	NE	1💡									1				
Westview	NW	1💡			8						1				

7.0 Capacity, Use, and Demand

The population of THPRD is growing at an estimated rate of 1.2% annually. The population of THPRD was 238,013 in 2015. Projections show a population growth of 12.6% over the next 20 years to 300,021. The largest growth areas are projected to be in the North Bethany planning area (10,721 residents by 2035) and South Cooper Mountain planning area (19,021 residents by 2035). The student population of the BSD is increasing at a rate of 1.2% annually, equivalent to the increases seen in the THPRD population growth. The BSD student population was 40,725 in 2015. Projections show a population growth of 6.5% over the next 10 years to an estimated population of 43,361.

The graph below details the past three years of THPRD monitored athletic facility use, the THPRD population and the BSD population. It is important to note that the tournament and rentals use are not considered drivers for the development of athletic facilities. These uses contribute to cost recovery goals and are only allocated use after THPRD priority programs have been allocated time.

Figure 7

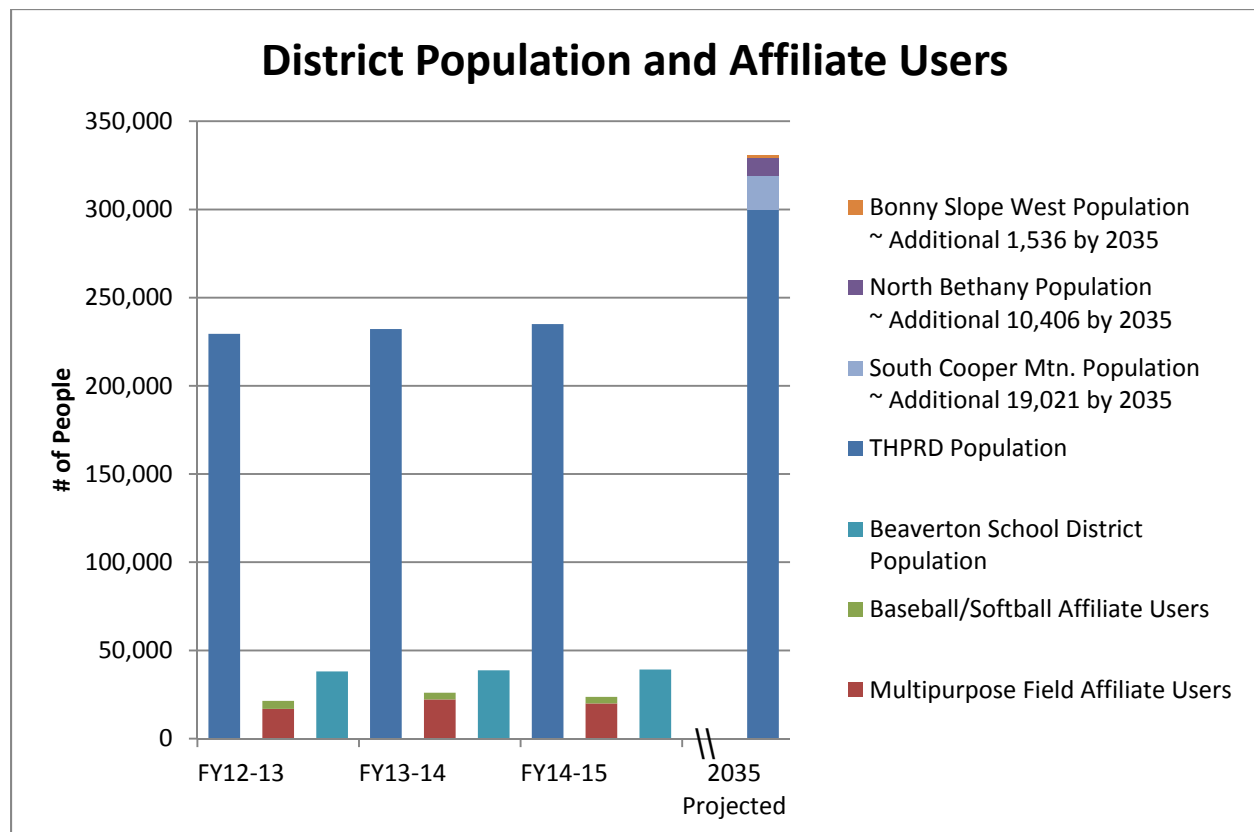

THPRD is currently meeting demand, as measured through the following, with existing facilities:

1. Number of hours available.
2. Number of usable hours. Excludes: hours while school is in session, non-permitted school field hours, unusable field condition hours, winter and summer closures of grass fields, BSD no-use hours, and field rest & recovery hours.
3. Number of hours considered desired by affiliate programs (M-F after 5:00pm and Saturdays).
4. Number of hours used. Includes: billable affiliate hours, tournament hours, THPRD internal program hours, contract hours, rainout hours, and rental hours.

Figure 8

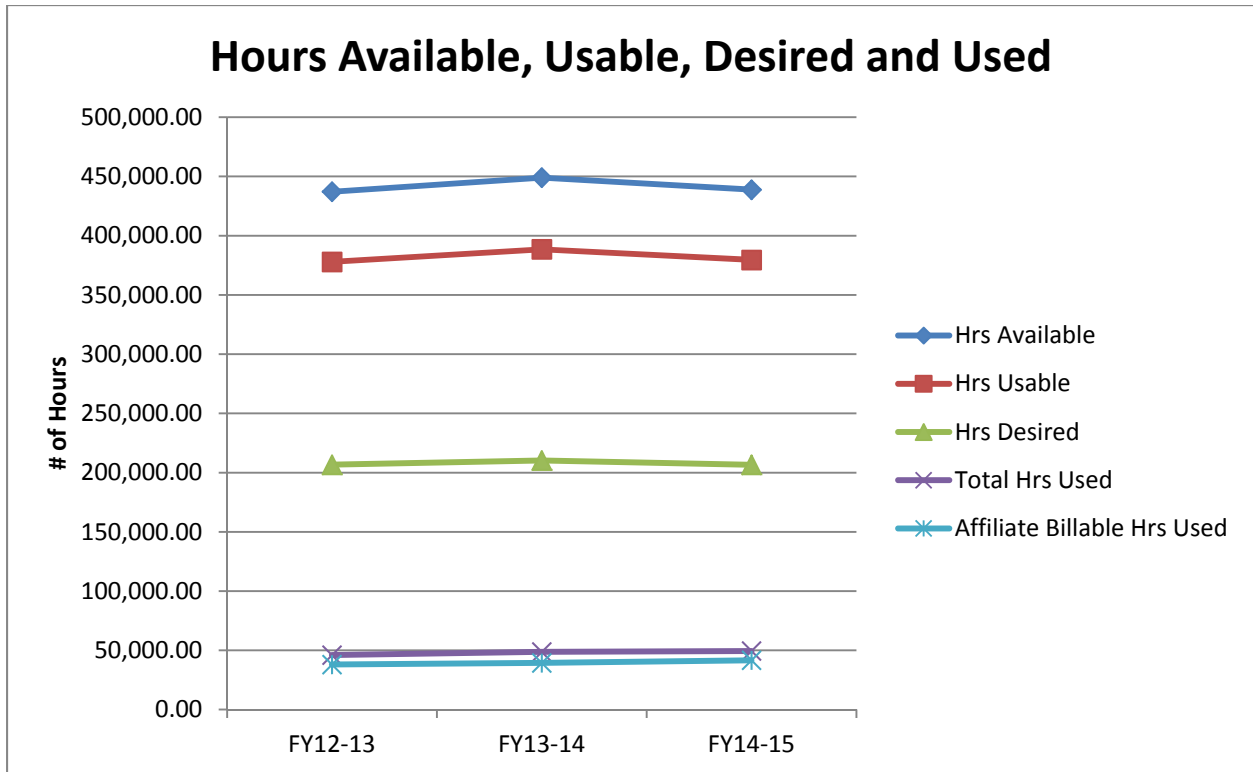
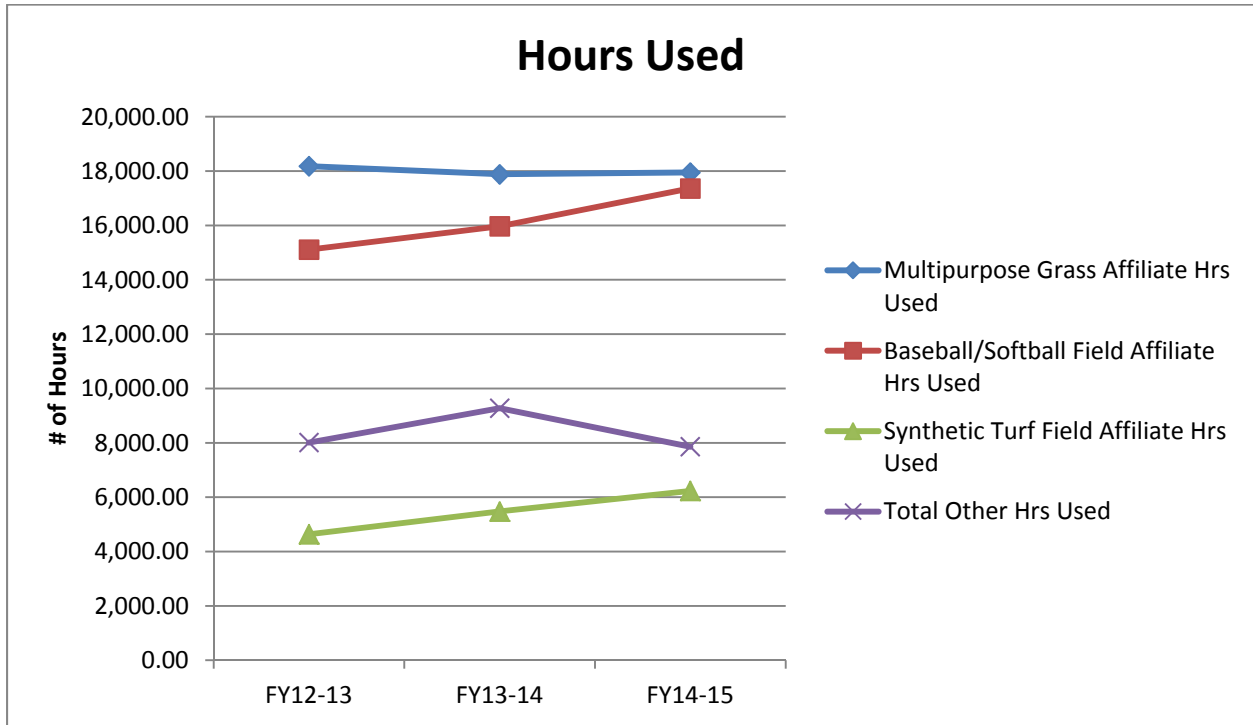

Figure 9



In 2015, THPRD owned, operated, or maintained 425 athletic facilities – 259 of which are monitored or permitted – for a combined total of 438,854 hours of available time. THPRD allocated and scheduled use of 49,398.5 hours of athletic facility time to 23,680 users of monitored facilities.



The following table shows the utilization of athletic facilities by THPRD affiliated organizations, for the past three fiscal years, by field type and quadrant, based on hours used and total number of users by sport.

Table 4

Affiliate Users and Affiliate Billable Hours Used by Sport

Sport	Quadrant	FY12-13		FY13-14		FY14-15	
		# of Affiliate Users	Affiliate Billable Hrs Used	# of Affiliate Users	Affiliate Billable Hrs Used	# of Affiliate Users	Affiliate Billable Hrs Used
Baseball/Softball	NE		2,474.00		2,688.50		2,840.00
	NW		6,294.50		6,073.70		6,942.75
	SE		2,822.00		2,912.50		3,920.50
	SW		3,521.50		4,296.00		3,660.50
	Total	4,544	15,112.00	3,815	15,970.70	3,709	17,363.75
Soccer	NE		3,186.50		3,230.00		3,188.00
	NW		7,037.00		7,376.25		8,467.25
	SE		3,440.50		3,433.50		3,679.00
	SW		2,933.75		2,297.00		1,746.00
	Total	14,196	16,597.75	19,696	16,336.75	17,107	17,080.25
Football	NE		164.00		196.00		325.00
	NW		798.50		1,030.00		1,081.25
	SE		885.00		965.00		607.00
	SW		732.00		644.50		538.50
	Total	1,056	2,579.50	926	2,835.50	911	2,551.75
Lacrosse	NE		104.75		237.50		340.00
	NW		1,640.50		2,048.75		2,034.25
	SE		1,299.75		1,122.00		1,317.75
	SW		592.00		775.50		853.00
	Total	1,573	3,637.00	1,569	4,183.75	1,953	4,545.00

The number of users participating in affiliated sports programs that utilize THPRD permitted athletic fields increased 10.8% between 2012 and 2015. In 2015 the affiliated organizations used 41,540.75 hours of athletic field time. Lacrosse and soccer have gained in popularity while football and baseball/softball have slightly decreased in participation.



8.0 Future Conditions

Future conditions, by type of facility, will be determined by referencing the 2013 Comprehensive Plan Update, Parks and Program Functional Plans, attendance, hours requested, and usable hours. Our ability to meet future demand will be measured by monitoring the following:

1. Number of hours available.
2. Number of usable hours. Excludes: hours while school is in session, non-permitted school field hours, unusable field condition hours, winter and summer closures of grass fields, BSD no-use hours, and field rest & recovery hours.
3. Number of hours used. Includes: billable affiliate hours, tournament hours, THPRD internal program hours, contract hours, rainout hours, and rental hours.

The surplus or deficit of hours in a facility or quadrant will guide the development of an athletic facility, repurposing or redevelopment of a facility to meet demand, or a review of assignment of facilities to balance use.

In addition to use-generated demand, we will also monitor local, regional, and national trends in sport participation, trends in local population including projected growth areas, and changes in demand or use. Our sources will include, among others, BSD attendance projections and census and growth projections.

As future demand and needs are identified, an integral part of the athletic facility planning and development process will be the Access for All initiative. Access for All is a THPRD initiative intended to address gaps in services and programming for underserved populations. Despite progress in social attitudes, people with disabilities continue to experience stigma and exclusion, as well as social and economic marginalization. The need for inclusive, accessible programs and facilities for children and adults with disabilities far outpaces available services.

THPRD provides inclusion services and specialized recreation programs. The vision statement for Inclusion Services and Specialized Recreation is:

“Tualatin Hills Park & Recreation District promotes the power of choice to enhance the quality of life for individuals of all abilities. We do this by providing diverse, accessible recreation in an environment that promotes dignity, success, and fun.”

Population shifts have profound ramifications for the district. To successfully meet our mission, we will need to address changes in several areas:

- **Programming:** Provide affordable access to programs and athletic facilities that target the interests of our multicultural and underserved residents.
- **Engagement:** To be certain THPRD hears the opinions and values of all cultures in our service area – THPRD will market programs to specific audiences, and encourage all

populations to serve on advisory committees and to volunteer in planning and implementing programs and special events.

- **Communication:** Determine the most effective means to communicate and market our services to all cultures.

All aspects of diversity are important when effectively programming recreational activities and athletic facilities in our community. The vision statement for our diversity program is:

“We provide all individuals the opportunity to play, learn, and explore, and all employees and volunteers the opportunity to further the district’s mission. We do this by removing barriers to participation, fostering an inclusive culture, and offering programs that celebrate the district’s diverse population.”

It is important that financial barriers are removed or minimized when working to address culture, equity, and diversity. To assist with this effort, THPRD has a scholarship program that provides need-based assistance to residents using THPRD programs and facilities.

9.0 Community Input on Facility Needs and Use

Input and diversified involvement is important to the decision making process for the development of new, and repurposing of existing, athletic facilities. Property owner(s) (e.g., BSD, THPRD, etc.), community partners, users/residents, and staff, are all involved. This group considers the following in the decision making process: impacts to other user groups, future needs for the facility, budgetary impacts, and current inventory and existing conditions of each facility. As a reference for public involvement, THPRD has established Community Outreach Procedures, Operating Procedure 4.01.01.

THPRD has established a clear and consistent procedure for informing the general public, neighborhood residents, and stakeholder groups in advance of various types and levels of district activities. Activities could include general maintenance work, master planning, natural resource work, and all types of site and facility construction projects. In general, public process involves the following principles:

- a) The district’s Parks Functional Plan addresses public involvement and, where appropriate, should be considered whenever new athletic facilities are being implemented.
- b) The Community Outreach Procedure provides community outreach requirements for maintenance, planning, natural resource, and improvement projects. It defines project levels, decision making authority, criteria, community outreach requirements, and project examples.
- c) The Community Outreach Procedure comprises 5 levels. Key components addressed in each level include:
 - Is community outreach required?
 - Is notification signage required?
 - Is written notification required?

- Is a neighborhood meeting required?
- Decision making authority

Public input received during public outreach is integral to the district’s planning and design process. Among other important factors, public input helps inform and guide the design of athletic facilities to ensure that stakeholder needs and preferences are being met.

10.0 Meeting Future Athletic Facility Needs Cost-Effectively

THPRD will look for the most cost-effective methods to meet its future athletic facility needs. A key strategy for meeting the need for athletic fields is to determine whether to develop or install synthetic turf fields vs. natural grass athletic fields based on the following factors:

1. Annual maintenance cost comparisons of full-size synthetic vs. natural grass (based on 2015 dollars)
 - a. Full size synthetic turf field = \$4,000 to \$6,000
 - b. Natural grass (native soil) non-irrigated field = \$2,000 to \$4,000
 - c. Natural grass (native soil) baseball/softball field = \$12,000 to \$16,000
 - d. Natural grass (native soil) irrigated field = \$8,000 to \$12,000
 - e. Natural grass (sand-base) field = \$16,000 to \$20,000
2. Replacement costs (expected lifespan of 10 years)
 - a. Full size synthetic turf field = \$500,000 to \$700,000
3. Development costs as determined through the planning process. These will be affected by project or site-specific conditions (including governing body sanctioning requirements) as determined by the design team.
4. Hours of use comparison
 - a. Synthetic turf fields do not require an annual rest & recovery period and they allow for all-weather play, which results in approximately 900 additional hours of usage annually per field over natural grass (native soil and/or sand-base) fields.

11.0 Future Athletic Facilities Through Land Acquisitions

THPRD will procure land/space for athletic facilities through land acquisitions, and shared use IGAs based on need.

As with land acquisitions for new parks (refer to Parks Functional Plan, Section 4.1.1), minimum expectations for land acquisitions for athletic fields and courts generally relate to acquiring sites that are suitable for development and include the following:

1. Developable area of sufficient size for the specific field, court type, or facility, and supporting amenities and access ways.
2. A location that is relatively flat.
3. A location that is accessible and responsive to the needs of the intended user groups.
4. A location that is accessible and conducive to the operation and maintenance practices of the district.

5. Where appropriate, consider recommendations and standards identified in the Parks Functional Plan for athletic fields and courts.
6. Where appropriate, consider recommendations and standards identified in the Natural Resources Functional Plan when natural resources are present.
7. Where appropriate, consider recommendations and standards identified in the Trails Functional Plan where trails occur or are planned.

12.0 Partnerships and Shared Use Intergovernmental Agreements

THPRD will enter into partnerships and shared use IGAs based on need and efficient use of resources. An IGA is conducted between two governing bodies to share the use of facilities or resources for the betterment of both parties and the community. In developing and implementing IGAs, THPRD follows District Compiled Policies (DCP) (refer to Chapter 5 – Public Contracting & Agreements, 5.17 Intergovernmental Agreements). Examples of IGAs that have cost-effectively improved access to athletic facilities for the community are the shared use of fields and gyms with BSD and a land use agreement with TVWD for athletic field development.

13.0 New and Repurposed Facilities

THPRD occasionally experiences loss of athletic facilities due to cancellation of use agreements, school expansion, land redevelopment, lack of use, or changes in regional and local sports and population trends. To address athletic facility loss in the most cost-effective way, THPRD may develop new facilities and/or redevelop or repurpose existing facilities. To find the best options, THPRD considers current facility use, impacts resulting from the loss of space, user demand and need, and future growth.

Before developing new facilities or redeveloping or repurposing existing facilities, THPRD considers what services, programs, and facilities already exist in the service area; these programs and services may be private or public. Before investing public dollars, THPRD will determine if the program has an unmet need, the facility already exists and has no additional capacity, and if THPRD can cost-effectively operate the program or facility within cost recovery practices. Annual athletic facility utilization is tracked to assist with determining the best course of action, including lowering the level of service provided, or removing a facility from inventory.

Figure 10 on the following page represents the application of THPRD's planning and decision making process around facility development to meet population changes and growing demand. Represented is an aerial view of the Howard M. Terpenning Complex as it stood in 1990 and 2011. Since the original construction began in 1976, much has changed:

- In 1992 an air structure was added over the eastern outdoor tennis courts to increase availability, with a second air structure added in 2006 for an increased capacity of 8 covered courts.
- In 1996 two additional multipurpose sand-base fields, one adult softball field, a roller hockey rink and additional parking were added.

- In 1997 a grass field was repurposed to add a 60,000 sq. ft. Athletic Center.
- In 1999 a skate park was added, and in 2001 and 2005 two grass multipurpose fields were repurposed to synthetic turf fields for added capacity.
- In 2008 an additional skate park was added.

Figure 10

Howard M. Terpenning Complex



HMT aerial view circa 1990



HMT aerial view circa 2011

14.0 Facility Design, Layout Guidelines, and Materials

The spatial layout of an athletic facility on the land in terms of size and orientation is determined through the planning process. The layout standards may be adjusted to adhere to project or site-specific conditions (including governing bodies' sanctioning requirements) as determined by the design team. In addition to the spatial needs of the specific type of athletic facility, safety buffers, and safe integration of the facility use with the park or location must also be considered. The following series of twelve figures presents a general plan schematic for each field type that could be developed or repurposed.

See Appendices for specific diagrams.

THPRD Baseball/Softball Field (Figure 15)
THPRD Soccer Field (Figure 16)
THPRD Lacrosse Field (Figure 17)
THPRD Football Field (Figure 18)
THPRD Rugby Field (Figure 19)
THPRD Tennis Court (Figure 20)

THPRD Pickleball Court (Figure 21)
THPRD Basketball Court (Figure 22)
THPRD Sand Volleyball Court (Figure 23)
THPRD Bocce Court (Figure 24)
THPRD Cricket Pitch (Figure 25)

In addition to design considerations, the planning process will also determine the type of profile (i.e., the vertical section of a field or court system as related to the depth and materials). The profile standards shown may be modified to adhere to project or site-specific conditions as determined by the design team. The following figures represent profiles for the typical standard details for each type of field/court.

See Appendices for specific diagrams.

Synthetic Turf Profile (Figure 26)
Sand-base Sports Field Profile (Figure 27)
Native Field Profile with Sub-Surface Drainage (Figure 28)
Skinned Clay Infield Profile (Figure 29)
Asphalt Court Profile with Acrylic Surfacing (Figure 30)
Asphalt Court Profile (Figure 31)
Sand Volleyball Court Profile (Figure 32)
Bocce Court Profile (Figure 33)

15.0 Lighting

Field and court lighting is included for certain athletic facilities to increase the amount of usable time. The facility must be able to accommodate the additional play (increase in hours of use, proximity to homes) and be a cost-effective alternative to a new facility development. Ongoing costs associated with light use, maintenance and replacement are considered. Planning for lighting of athletic facilities will follow the established Community Outreach Procedures (refer

to Operating Procedure 4.01.01) for community input and feedback prior to final plans being developed. Lighting, when incorporated, will meet current jurisdictional code requirements. Lighting may include traditional lighting, LED lighting, automated systems, and/or other viable, cost-effective options.

16.0 Athletic Facility Amenities and Optional Structures

Amenities and optional structures (i.e., the furnishings and other elements provided in direct support of the athletic facility being developed) are determined through the planning process. The layout standards may be adjusted to adhere to project or site-specific conditions as determined by the design team. THPRD will consider recommendations and standards identified in the Parks Functional Plan for amenities. Facility amenities should take into consideration use of color schemes that promote easy visibility and/or contrast from adjacent park features. The following series of photos on pages 34-35 represent the standard furnishings used in THPRD athletic fields, and photos on page 36 depict optional structures in support of athletic facilities.

- Bleachers
- Player benches
- Trash/Recycling receptacles
- Drinking fountains
- Signage: Refer to the THPRD Signage Master Plan for additional details
- Restrooms – permanent and portable
- Concessions
- Dugouts
- Storage

Kiosks: Refer to the THPRD Signage Master Plan for additional details

Standard Furnishings

Bleachers



Player Benches



Trash Receptacles



Recycling Receptacles



Drinking Fountain



Kiosk



Standard Furnishings

Signage

**These athletic facilities
are maintained by the
Tualatin Hills Park
& Recreation District**



**Athletic Center
503/629-6330**

Synthetic Turf Field 2

Field Rules
FIELD USE PERMIT REQUIRED.
Call 503/629-6330 to obtain permit.

**The following are prohibited inside
the fenced area:**

- Metal cleats
- Littering
- Gum and candy
- Tobacco products (including chewing tobacco)
- Alcohol
- Sunflower seeds or shelled peanuts
- Golfing
- Batting practice
- Animals
- Chairs or canopies
- Liquids other than water

Park Patrol 971/246-0169
Violators subject to exclusion and/or fine.



Field Use By Permit Only

**UNAUTHORIZED USERS WILL
BE ASKED TO LEAVE.**

Permits will be checked and verified.
To obtain a valid field use permit, call:
Tualatin Hills Athletic Center
503/629-6330

**USO DEL CAMPO SOLO
CON PERMISO**

Si 10 usa sin autorizacion se le pedira
que se retire. Lost permisos seran
chequeados y verificados.

Violators subject to exclusion and/or fine.



Standard Structures

Restrooms



Portable Enclosure



Portable Enclosure

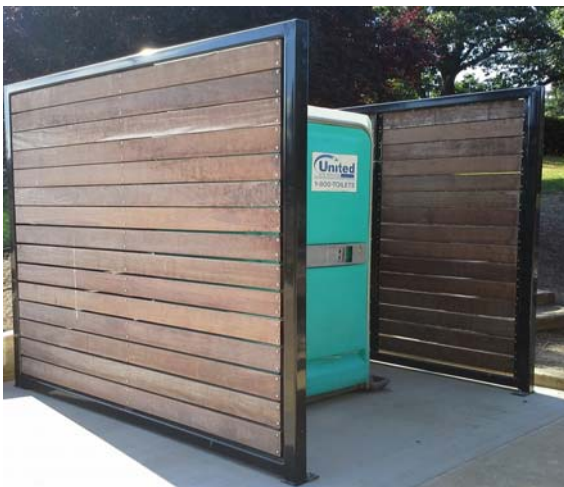

Concessions



Dugouts



Storage



17.0 Department Involvement, Design, and Review

All facility designs involve a design team, which is an advisory group consisting of representatives from each internal stakeholder department, and consultants. These teams are created for the purpose of informing the design process. Review of design drawings and specifications typically takes place during the design development and construction documentation phases. Comments are incorporated into the design documents before and after the community input process (refer to section 9.0, page 28 of this plan for more details).

18.0 Athletic Facility Assignment Priorities, Tiered System

Prior to 2007 THPRD assigned athletic facilities to affiliated organizations based on historical requests and use. The affiliated organizations requested facilities and were not charged use fees or required to record or substantiate use. This allocation model created an inefficient use of facilities resulting in an artificial demand and perceived deficiency of athletic facility capacity. In 2007 THPRD developed and implemented an allocation process that based the requests for facilities on need, specifically the number of hours necessary for the sport or organization to offer the program. All allocations are based on hours requested, available, and usable, measured by hours used and billed. This system of allocation has created efficient use of facilities and a resulting surplus of hours during non-peak seasons on some athletic fields.

Athletic facilities are assigned by facility type with priority based on THPRD's five (5) tiered system, unless superseded by an IGA (see section 4). These tiers, in order of priority, are:

1. THPRD program use.
2. Affiliates: Provide a service that THPRD would provide if they did not exist. Must be non-profit and community-based, focused on serving in-district needs and constituents.
3. Partners/Associates: Provide a service of community benefit. THPRD would not provide the activity or benefit if they did not exist. Must be non-profit and community-based, focused on serving in-district needs and constituents. Affiliates operate and exist as a result of Partners/Associates support, licensing, or sanctioning.
4. Other Non-Profit Renters: Exclusive use of space. Must be for non-profit use. For-profit enterprises are not eligible.
5. Private Renters: Exclusive use of space. The district reserves the right to refuse use to a business or individual.

In 2012 THPRD developed and implemented an affiliate policy to administer and guide the recognition of organizations within the tiers (refer to DCP 7.16 for details). The responsible party for the assignment of all athletic facilities is the representative submitting the request and signing the agreement. (Refer to DCP 6.01 and facility use agreement form for additional details on fees and charges.)

19.0 Maintenance Standards

THPRD has established maintenance standards for operations and practices, as outlined in the Maintenance Standards Manual. This manual includes details related to specific maintenance activities and should be referenced for the most current information relating to maintenance standards.

The athletic facilities maintenance department uses a zone management structure to provide safe athletic facilities based on programming needs, standards of quality, and the efficient use of available resources. Maintenance staff generally follow a schedule and/or route, but there is variability in the frequency, duration, and type of tasks to accommodate differences in seasonality, public use, or asset performance. Typical responsibilities of the athletic facilities maintenance staff may include:

- General Services:
 - Athletic field mowing
 - Turf maintenance (e.g., aeration, over seeding, fertilization, sand topdressing)
 - Daily game/field preparation
 - Trash removal
 - Athletic court blowing/debris removal
 - Safety inspections and reports
 - Pesticide application
 - Irrigation system maintenance
 - Installation/removal of soccer goals
- On-demand Services:
 - Graffiti removal
 - Vandalism repair
 - Snow/ice removal
 - Safety response
- Other Services:
 - Special event support
 - In-house construction projects
 - Capital project management

Maintenance Standards



Finished



20.0 Funding

A goal of THPRD is to create a balanced cost recovery model that identifies and establishes financial accountability and sustainability goals, while equally supporting the core values, vision, and mission of the district and the community it serves. As community needs grow and evolve, the district will continue to approach the allocation of taxpayer funds thoughtfully and responsibly in an effort to maintain the quality standards established for our programs and services.

By focusing on community benefit, we have established a cost recovery and pricing model that meets our core values as stewards of the public dollar and as a quality service provider.

The Cost Recovery Pyramid Methodology is used to sort categories of service and determine cost recovery targets. The pyramid details cost recovery and subsidy goals corresponding with the benefit received by the community as a whole. The percentages on the right denote the level of expected cost-recovery for that tier of the pyramid.

Figure 11

Cost Recovery Pyramid Methodology

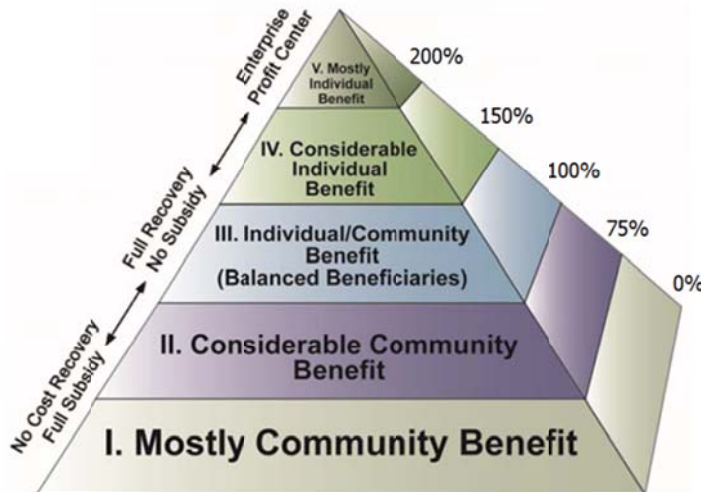

Ongoing operational costs of athletic facilities that are free, unmonitored, and open for public use are covered in the taxes assessed by the district. These facilities are considered Tier I on the pyramid and can include tennis and basketball courts in the parks, skate parks, the disc golf course, and unreserved athletic fields.

Ongoing operational costs (including maintenance and scheduling) of athletic facilities that are reserved for individual use or group use (reservations) and designated athletic fields (reserved for use) are offset through rental fees or field use fees. These athletic facilities are considered

Tier III or Tier IV and include sports complexes, synthetic turf fields, and monitored facilities. Fees are set in accordance with cost recovery targets and are adjusted annually to match inflation or changes to levels of service.

Facility funding methods include:

1. General Fund Capital
2. System Development Charges
3. Grants
4. Donations
5. General Obligation Bonds
6. Revenue Bonds

The district's capital improvement program (CIP) is a combination of deferred maintenance capital projects (athletic facility replacement or repair) and system development charges (SDC) development projects (new athletic facilities or increasing capacity of existing facilities). Additionally, the list takes into account the priority recommendations outlined for this functional plan. Projects in the CIP are then funded through the district's budgeting process with either general funds or SDC funds. Grants and donations may also be solicited to help fund projects identified in the CIP in an effort to maximize district resources.

As stated above, the two primary funding streams available to deliver projects in the CIP are:

General Fund Capital

The district's primary funding source is property tax revenues. These revenues go into the district's general fund and are then allocated for capital projects and maintenance operations on an annual basis. These funds are typically prioritized toward capital replacements.

System Development Charges

The district's secondary source of funding for improvements comes from its SDC fund. Since 1997 the district has collected fees on new residential and commercial development occurring within its service area. These fees can only be used for new development or improvements to existing facilities that expand capacity necessitated by new development. SDC funds cannot be used for capital replacement or maintenance purposes.

In lieu of paying SDC fees at the time of development, developers may enter into a memorandum of understanding (MOU) to construct athletic facility improvements in the amount of estimated SDC fees that would normally be charged. The MOU outlines specific improvements to be constructed for which credit will be issued. The MOU also includes language to ensure that such improvements meet district design standards and guidelines.

Grants

Multiple grant opportunities exist to fund athletic facility improvements, in part or wholly. Grant sources include private foundations, such as the United States Tennis Association, and

public agencies, such as the Oregon Parks and Recreation Department. Grants can be used to acquire land, fund an entire park development and/or just a portion of a facility, such as a field upgrade, amenities, or a sports court. Grants can also be used for new facility development or enhancement of existing facilities. The district will typically use SDC funds as a local match in order to leverage grant funds.

Donations

In certain instances, athletic facility improvements are donated to the district or provided to the district. This could include land, materials, products, and/or labor for the construction or installation of athletic facilities. In most instances, this occurs in conjunction with improvement projects of other public agencies, such as the Beaverton School District, Tualatin Valley Water District, or City of Beaverton. In some instances, facility improvements can come from private development or community groups seeking improvements to facilities in their neighborhoods.

General Obligation or Revenue Bond Funding

Bond funds can be used for a variety of projects based on how the bond is crafted, including land acquisition, new park development, redevelopment of existing parks, capital replacements, or a combination of these items. Bond funds can be short-term or long-term, and can be used for specific projects or many different projects. General Obligation bonds are approved by voters during a general or special election, and are supported by a dedicated property tax. Revenue bonds are approved by the Board and are full-faith and credit bonds supported by the district's general fund.

21.0 Measuring Our Results

THPRD will monitor the success of our athletic facilities by establishing our desired outcomes, tracking the relevant data on a regular basis, and using the data to measure our results. The THPRD Board of Directors has set annual goals related to the efficiency of our operations (based on both staff time and cost recovery), the efficiency of our use (based on hours), and our level of sustainability (based on utilities consumption).

THPRD will track staff hours allocated to athletic facilities for programming and maintenance, budgeted expenses and revenue, actual costs and revenue (including utility costs), utility units consumed, and the following categories of hours:

1. Number of hours available.
2. Number of usable hours. Excludes: hours while school is in session, non-permitted school field hours, unusable field condition hours, winter and summer closures of grass fields, BSD no-use hours, and field rest & recovery hours.
3. Number of hours used. Includes: billable affiliate hours, tournament hours, THPRD internal program hours, contract hours, rainout hours, and rental hours.

Based on this data, we will calculate the following measurements:

1. Staff time per hour used

2. Staff time per acre or square foot
3. Maintenance cost per hour used
4. Maintenance cost per acre or square foot
5. Revenue per hour used
6. Revenue per acre or square foot
7. Cost recovery percentage based on budget
8. Cost recovery percentage based on actuals
9. Percentage of hours used vs. hours allocated
10. Percentage of hours billable vs. hours used
11. Year-over-year trends in hours used
12. Utilities units consumed per acre or square foot



22.0 Recommendations: 2015-2020

This Athletic Facilities Functional Plan addresses athletic facilities owned, operated or permitted by THPRD. The plan covers athletic facilities that are not within the confines of a recreation center, they are monitored and non-monitored facilities located outdoors. For purposes of these recommendations, athletic facilities are viewed in two categories: permitted athletic fields and non-permitted athletic facilities.

- a) Permitted athletic fields can be sports complexes, a specific use location, or an athletic field at a school or in a park. *Examples include but are not limited to: HMT Recreation Complex, Sunset Park, Powerlines sports fields, and Nancy Ryles Elementary School.*
- b) Non-permitted athletic facilities can be part of a sports complex, can be a specific use location, or can be at a school or in a park. *Examples include but are not limited to: tennis courts, bocce court, skate parks, basketball pads, volleyball courts, etc.*

In FY 2014-15 THPRD permitted the use of 259 athletic fields that were utilized for the purpose of offering THPRD programs, community based sports programs (through affiliates), tournaments, and rentals.

- a) THPRD is meeting the needs of the community as measured by expressed demand for facilities being met with excess capacity in some areas and on certain types of facilities.
- b) Peak demand is fall (August through November) and spring (March through June).
- c) THPRD has excess capacity on baseball/softball fields in general.
- d) THPRD has excess capacity on all fields in the non-peak summer (July through August) and winter (November through February) months.

The 2008 bond measure provided additional capacity for athletic facilities, specifically athletic fields. To date construction has been completed and facilities have been opened which are included in this plan's inventories.

Table 5

Completed projects, 2008 Bond measure

Site	Quadrant	Use	Status
AM Kennedy Park Redevelopment	NE	Multipurpose	Completed
Cedar Mill Park Redevelopment	NE	Soccer/Football/Lacrosse	Completed
Meadow Way Park	SE	Soccer/Football/Lacrosse	Completed
Barsotti Park	SW	Multipurpose	Completed
Winkelman Park	SW	Baseball/Softball	Completed
Cedar Mill Elementary School	NE	Baseball/Softball	Completed

Included in the 2008 bond were park developments and park redevelopments. Through the public process new athletic facilities added include:

Schiffler Park Redevelopment	SE	Skate Spot and (1) Basketball Pad	Completed
Barsotti Park	SW	Youth Tennis Court	Completed

Additional athletic facilities provided in the 2008 bond are in final planning stages, or under construction. These additional facilities will increase capacity in three quadrants, addressing current needs as identified in the 2008 bond planning.

Cedar Hills Park Redevelopment	NE	Multipurpose synthetic turf	Sand Volleyball Court
SW Quadrant Community Park	SW	Two multipurpose synthetic turf fields, 90-foot baseball field, Champions Too field (synthetic turf)	
Conestoga Middle School	SE	Multipurpose synthetic turf	N/A

Significant factors and considerations influencing these recommendations include:

Use trends:

Overall the number of affiliate users has increased 10.8% over the past three years while the overall population of THPRD continues to grow at a rate of 1.2% annually. While THPRD has sufficient capacity on existing permitted facilities, the location of the facilities in proximity to new and developing population centers is challenging. The largest growth areas are projected to be in the North Bethany planning area (10,721 residents projected by 2035) and South Cooper Mountain planning area (19,021 residents projected by 2035), both of which are not

currently being serviced. The student population of the BSD is increasing at a rate of 1.2% annually, equivalent to the increases seen in the THPRD population growth. In 2015 the BSD student population was 40,725. Projections show a population growth of 6.5% over the next 10 years to an estimated population of 43,361.

Figure 12

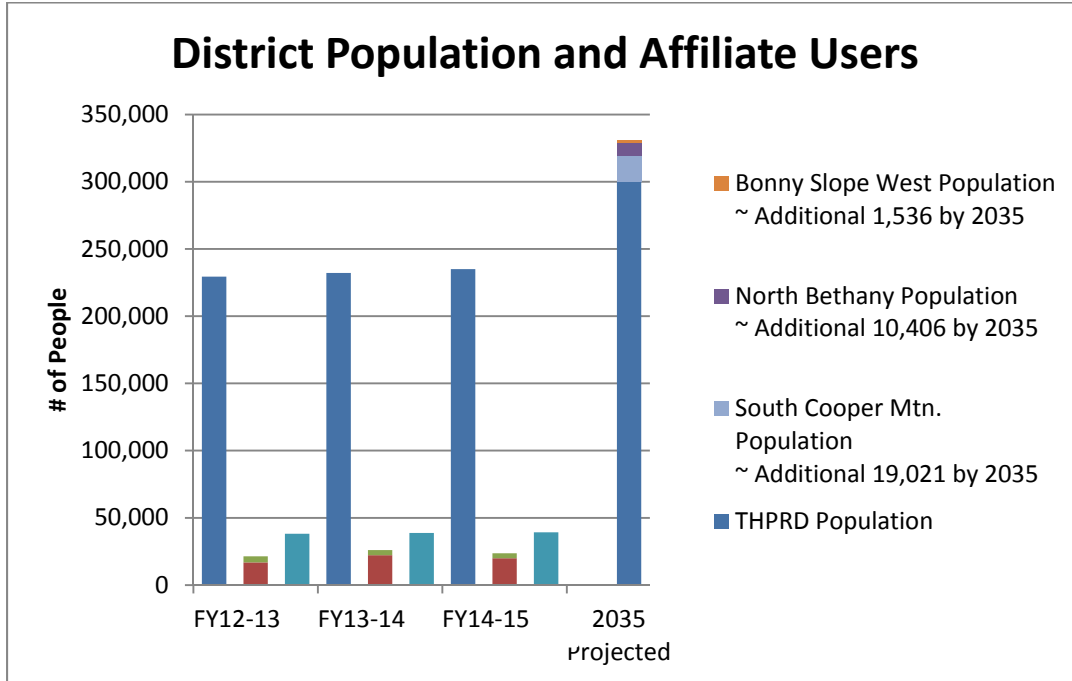

Figure 13

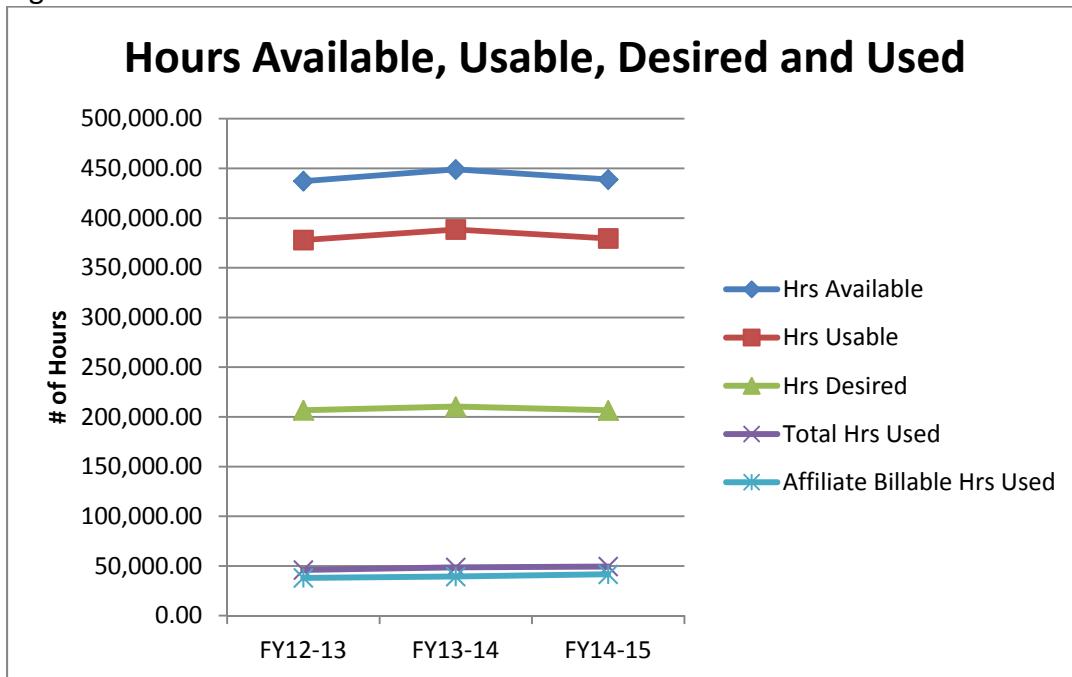

Figure 14

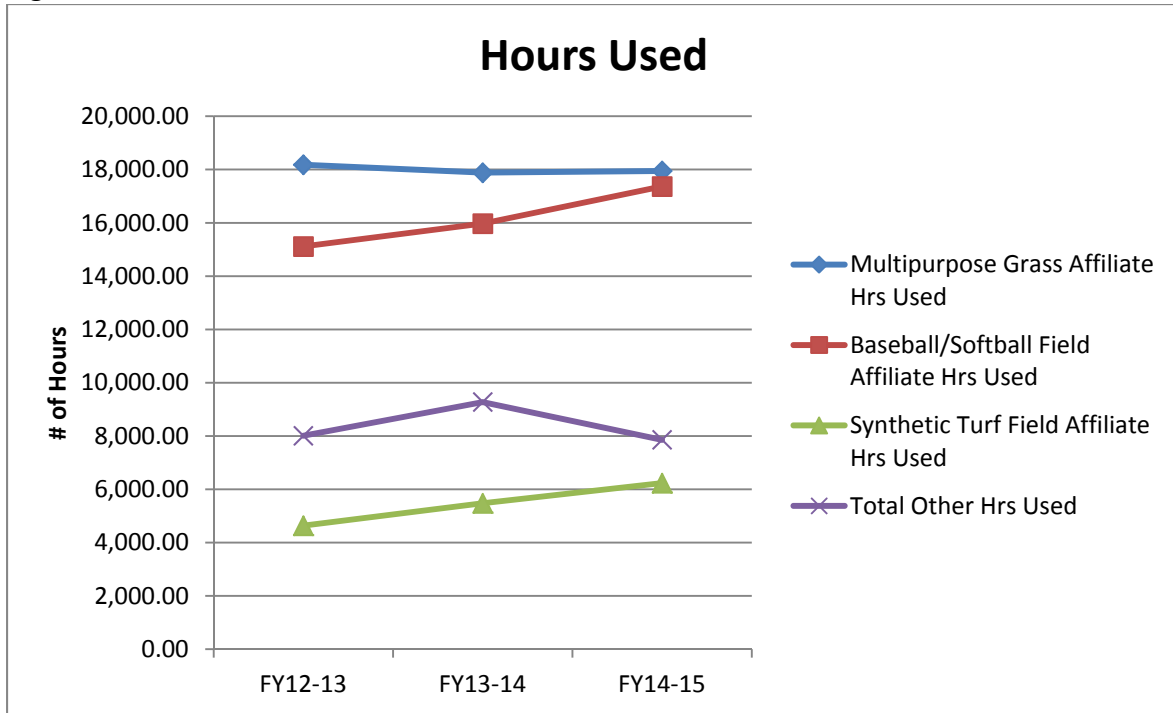

Table 6

Affiliate Users and Affiliate Billable Hours Used by Sport

Sport	Quadrant	FY12-13		FY13-14		FY14-15	
		# of Affiliate Users	Affiliate Billable Hrs Used	# of Affiliate Users	Affiliate Billable Hrs Used	# of Affiliate Users	Affiliate Billable Hrs Used
Baseball/Softball	NE		2,474.00		2,688.50		2,840.00
	NW		6,294.50		6,073.70		6,942.75
	SE		2,822.00		2,912.50		3,920.50
	SW		3,521.50		4,296.00		3,660.50
	Total	4,544	15,112.00	3,815	15,970.70	3,709	17,363.75
Soccer	NE		3,186.50		3,230.00		3,188.00
	NW		7,037.00		7,376.25		8,467.25
	SE		3,440.50		3,433.50		3,679.00
	SW		2,933.75		2,297.00		1,746.00
	Total	14,196	16,597.75	19,696	16,336.75	17,107	17,080.25
Football	NE		164.00		196.00		325.00
	NW		798.50		1,030.00		1,081.25
	SE		885.00		965.00		607.00
	SW		732.00		644.50		538.50
	Total	1,056	2,579.50	926	2,835.50	911	2,551.75
Lacrosse	NE		104.75		237.50		340.00
	NW		1,640.50		2,048.75		2,034.25
	SE		1,299.75		1,122.00		1,317.75
	SW		592.00		775.50		853.00
	Total	1,573	3,637.00	1,569	4,183.75	1,953	4,545.00

Access

The location of facilities and proximity to population centers is important to consider as part of these recommendations. Access including vehicular transportation, bike routes, walkability, community demand, and community support are all related to the specific location of an athletic facility recommendation. Barriers such as Highway 26, Highway 217, Farmington Road, Murray Road, and Scholls Ferry Road influence travel time not only to gain access to an athletic facility but also walkability.

Access for All Initiative

Because of an increase in population and shifting demographics, this plan embraces the vision set forth for diversity at THPRD; this statement is:

“We provide all individuals the opportunity to play, learn, and explore, and all employees and volunteers the opportunity to further the district's mission. We do this by removing barriers to participation, fostering an inclusive culture, and offering programs that celebrate the district's diverse population.”

To advance diversity in our offerings, we strive to provide access for all, which means we look for opportunities to include:

1. Children and adults with physical and developmental disabilities
2. People in low income situations
3. People who experience barriers due to language and culture
4. People who struggle with mobility and transportation
5. Senior citizens or other groups that may face barriers to full participation

“Tualatin Hills Park & Recreation District promotes the power of choice to enhance the quality of life for individuals of all abilities. We do this by providing diverse, accessible recreation in an environment that promotes dignity, success, and fun.”

Cost Recovery

THPRD instituted a field use fee in 2007 as an early step to establishing cost recovery. Ongoing operational costs of athletic facilities that are free, unmonitored and open for public use are covered in the taxes assessed by the district. These facilities are considered Tier I by the cost recovery pyramid methodology and can include tennis and basketball courts in the parks, skate parks, the disc golf course, and unreserved athletic fields.

Ongoing operational costs (including maintenance and scheduling) of athletic facilities that are reserved for individual or group use (reservations), and designated athletic fields (reserved for use), are offset through rental fees or field use fees. These athletic facilities are considered Tier III or Tier IV by the cost recovery pyramid methodology and include sports complexes, synthetic turf fields, and monitored facilities. Fees are set in accordance with cost recovery targets and are adjusted annually to match inflation, changes to levels of service or changes in demand.

Based on population center development trends, and meeting current needs with excess capacity in existing population centers, the following recommendations have been developed.

Recommendations: General Action Steps

1. THPRD will continue to partner in the development of and access to athletic facilities located in neighborhoods or near population centers when appropriate.

Examples include but are not limited to:

- a. Location is in an identified area of demand for facilities
- b. Location or facility meets a defined need
- c. Location or facility provides a new service

2. THPRD will continue to evaluate and track the use of all athletic facilities.

Examples include but are not limited to:

- a. Determine levels of use and identify efficiencies of assignment
- b. Review assignment process to increase access for adults and non-traditional sports
- c. Assist in identifying levels of demand or surplus capacity
- d. Maintain the ratio of population to facility availability
- e. Identify facilities that can be repurposed or moved to a lower level of service

3. THPRD will track the relationship of facility use fees and resulting changes in demand or use to assist with projecting future needs.

- a. Increase use of targeted facilities to assist with improving cost recovery

4. THPRD will evaluate the permitted athletic facility assignment procedures.

- a. Maximize use of synthetic turf fields
- b. Maximize use of facilities with lights
- c. Maximize use of athletic facility locations with multiple fields for efficiency

5. THPRD will consider how every decision or plan related to athletic facilities addresses Access for All goals or advances Access for All priorities.

6. THPRD will routinely check in with other community experts and partners to determine gaps in services.

- a. Use this information to prioritize planning and the use of athletic facilities
- b. Identify and evaluate opportunities to partner on athletic facilities and programs

Recommendations: Priority Action Steps

7. THPRD will develop a system of collecting and tracking the use of tennis courts, basketball courts, and other special use facilities, in parks or at non-monitored facilities.

- a. Define the demand for, and determine the appropriate locations for repurposing or redevelopment of existing facilities to expand services in a cost effective manner

8. THPRD will complete planning and construct the balance of the athletic facilities identified in the 2008 funding measure.
 - a. NW quadrant multipurpose grass youth athletic field, TBD
 - b. SW quadrant multipurpose grass youth athletic field, Living Hope Church
9. THPRD will increase athletic facility allocation for non-mainstream sports.
 Cricket is currently assigned one day a week at one location. The sport is in demand among an identified underserved ethnic population.
 - a. Assure that the double wide synthetic turf field at the SW quadrant Community Park can accommodate cricket play
 - b. Review scheduling practices to provide time for cricket at the PCC Rock Creek Recreation Facility in the NW quadrant
10. THPRD will continue to monitor and track all local, regional, and national sports and activity trends.
 - a. Identify underserved population needs related to athletic facilities
 - b. Identify non-mainstream sports facility demand
 - c. Identify trends that require advance planning to develop, repurpose, or redevelop athletic facilities
 - d. Identify opportunities to increase use, or add new uses, of athletic facilities
11. THPRD will address growth in the North Bethany planning area. (NE quadrant)
 The North Bethany planning area is growing at a faster rate than was previously anticipated. This planning area is estimated to see a population growth of 10,721 residents and 5,000 housing units in the next 20 years.
 - a. Identify and execute partnerships to provide two baseball and softball fields that provide 3,954 hours of available time and two youth multipurpose grass athletic fields that provide 3,658 hours of multipurpose athletic field capacity.
 - b. Develop full sized athletic field or fields on THPRD property that will yield 5,096 hours of multipurpose athletic field capacity.
 - c. Develop one youth multipurpose grass athletic field on THPRD property that will yield 1,829 hours of multipurpose athletic field capacity.
 - d. Provide space in all new park developments for athletic facilities and amenities through the planning process. These include but are not limited to: tennis, volleyball, basketball, and casual use.
 - e. Consider assuming operations of the Springville K-8 multipurpose grass youth athletic field.
12. THPRD will address planned growth in the South Cooper Mountain planning area. (SW quadrant)
 The South Cooper Mountain planning area is in the initial stages of development with an estimated population of 19,021 and between 2,900 and 3,530 housing units by 2035.

Additionally, BSD is adjusting boundaries to shift the student population south to make room at schools in the NW quadrant. This provides a cost-effective partnering opportunity to co-develop athletic facilities.

- a. Identify and execute partnerships that will provide one youth baseball and softball field, 1,977 hours; one youth multipurpose grass athletic field, 1,829 hours; a full-sized athletic field or fields that can provide 3,954 hours of multipurpose athletic field capacity; and a minimum of four tennis courts.
- b. Provide space in all new park developments for athletic facilities and amenities through the planning process. These include but are not limited to: tennis, volleyball, basketball, and casual use.

Glossary

Affiliate: An organization that provides a service that THPRD would provide if they did not exist. Must be non-profit and community based, focused on serving in-district needs and constituents.

Assignment: The process of reserving a space for use by a designated group. Synonymous with a rental.

District Complied Policy (DCP): Policy adopted by the board of directors to provide operational guidance and governance.

Rainout: The declaration of a field that is not in playable shape due to weather conditions.

Rest & recovery: The designated period of time a field is closed to use for repair or damage prevention.

System Development Charge (SDC): Fees that the district collects on new residential and commercial development occurring within its service area. These fees can only be used for new park development or improvements to existing facilities to expand capacity necessitated by new development. SDC funds cannot be used for capital replacement or maintenance purposes.

Appendices

Layout Guidelines

- Figure 15: Baseball/Softball Dimensions
- Figure 16: Soccer Field Dimensions
- Figure 17: Lacrosse Field Dimensions
- Figure 18: Football Field Dimensions
- Figure 19: Rugby Field Dimensions
- Figure 20: Tennis Court Dimensions
- Figure 21: Pickleball Court Dimensions
- Figure 22: Basketball Court Dimensions
- Figure 23: Sand Volleyball Court Dimensions
- Figure 24: Bocce Court Dimensions
- Figure 25: Cricket Pitch Dimensions

Athletic Facility Profiles

- Figure 26: Synthetic Turf Profile
- Figure 27: Sand Base Sports Field
- Figure 28: Native Field with Sub-surface Drainage
- Figure 29: Skinned Clay Infield Detail
- Figure 30: Asphalt Court Sections with Acrylic Surfacing
- Figure 31: Asphalt Court Section
- Figure 32: Sand Volleyball Court Section
- Figure 33: Bocce Court Profile

Baseball/Softball Field Dimensions

Figure 15



Key for THPRD baseball standards:

- A. Home base to Backstop
- B. Distance of Foul line
- C. Distance to Center Field
- D. Height of Backstop (see specs for backstop height and width)
- E. Distance of Fence Wings
- F. Distance of Safety Zone from end of base/foul line (No obstructions)
 - a. Towards outfield
 - b. Towards fence wings
- G. Safety Buffer (No man-made obstructions)
- H. Distance to Skinned Infield Arc

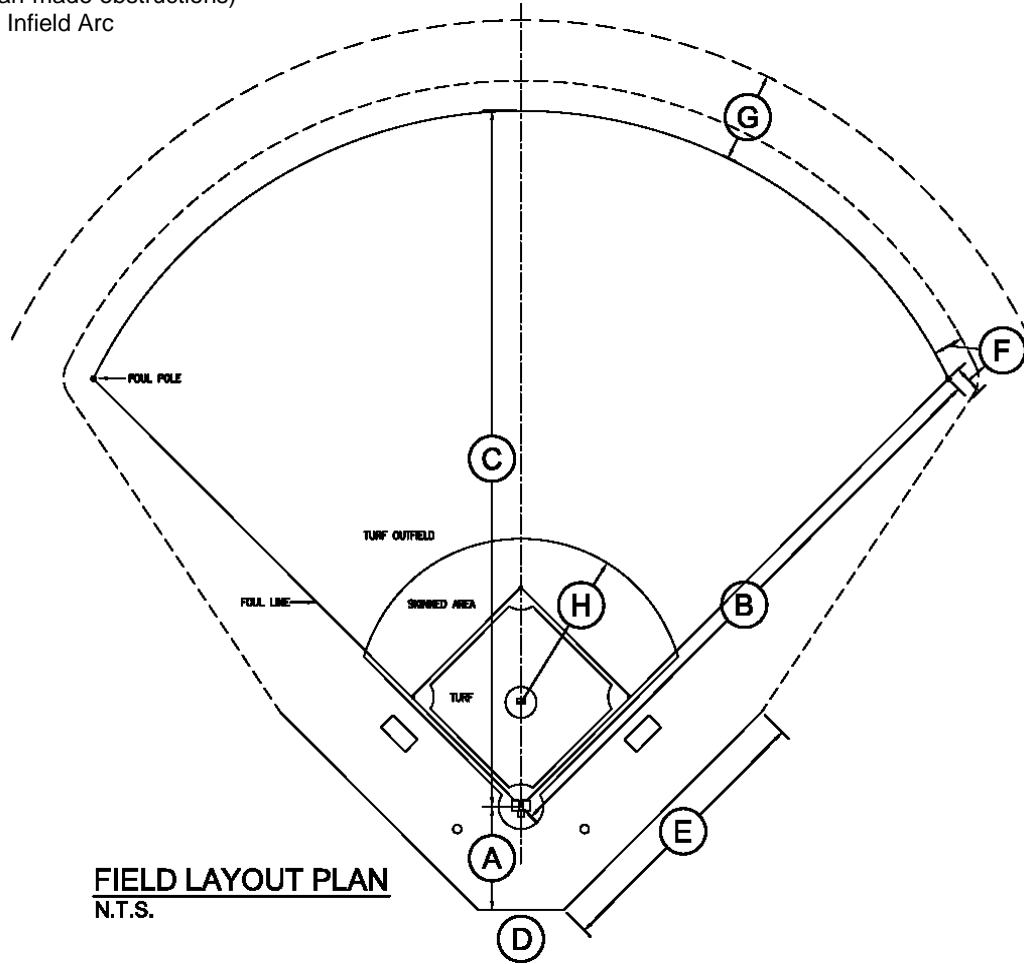

Baseball/Softball Fields

		A	B	C	D	E	F	G	H
Field Type	User Group	Home Base to Backstop	Foul Line	Center Field	Backstop Height	Wing Fence	Run Out	Safety Buffer	Infield Arc
60' baseline	5-12yr old	15'-25'	200'	200'	16' or 30'	100'	15'	50'	55'
70' baseline	10-14yr old	15'-30'	200'	250'	16' or 30'	100'	15'	50'	65'
80' baseline	13-14yr old	25'-40'	250'	300'	30'	110'	15'	50'	80'
90' baseline	13-18yr old	25'-60'	320'	400'	30'	120'	15'	50'	95'

Typical Field Programming: Season

Spring / Summer

Program

Baseball / Softball

Notes:

- 1) 60'/70' field backstop heights may vary based on site conditions.
- 2) Irrigation/drainage system boxes and vaults shall be located outside the field of play whenever possible. This includes the 15' run out zone. If boxes or vaults are located within these areas, they must be buried a minimum of 4" below grade.
- 3) No man made structures shall be designed or constructed within the Safety Buffer. Examples include play areas, shelters, site furnishings and other hard surfaces.

Soccer Field Dimensions

Figure 16

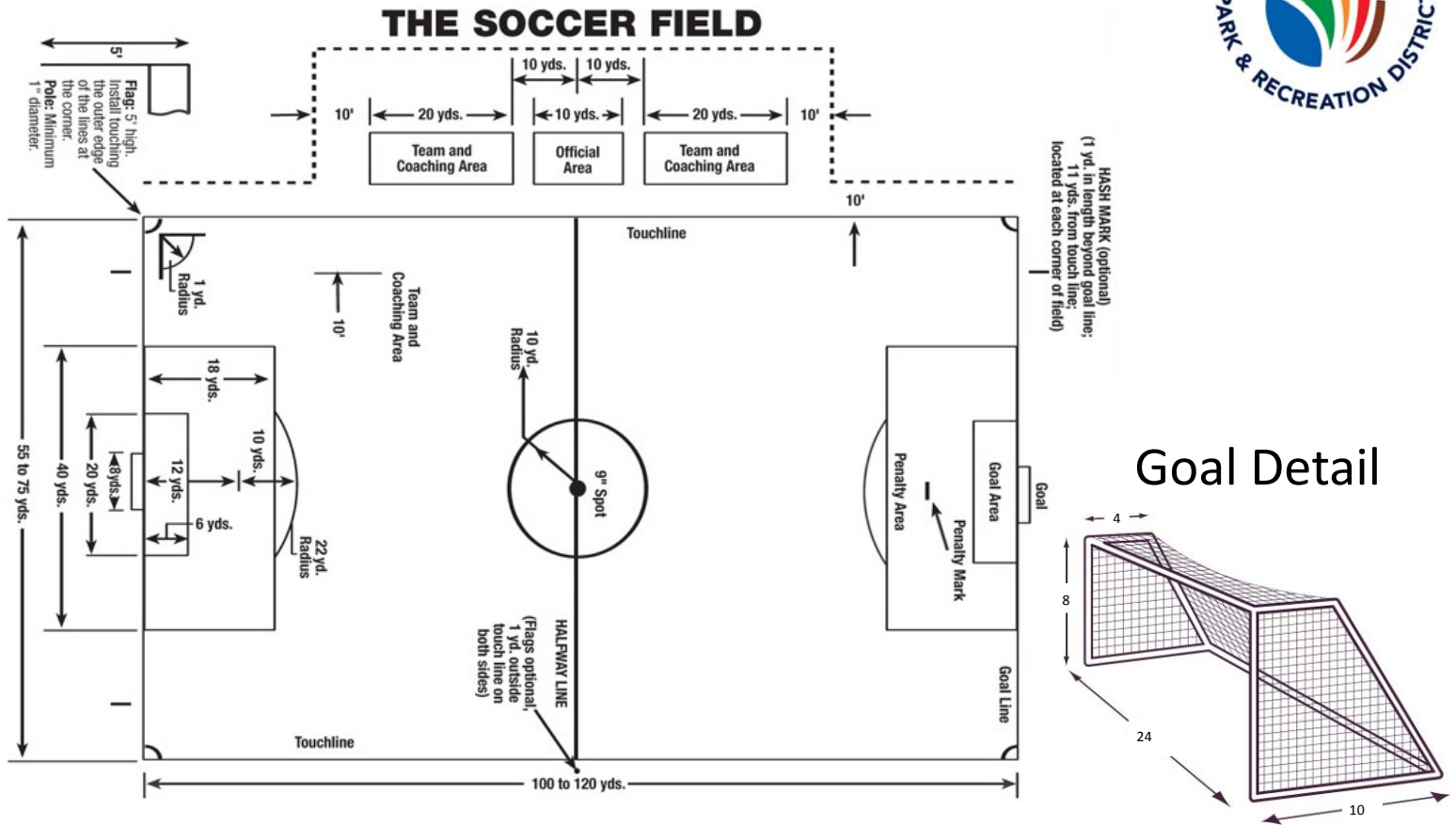

Soccer Fields

Field Type	User Group	Minimum Field Size	Optimum Field Size	Side Lines	End Line Run Out	Optimum w/ Run Outs
U8		75' x 105'	75 x 105	6'	10'	87' x 125'
U9/10		105' x 150'	135' x 180'	6'	10'	147' x 200'
U11		135' x 210'	165' x 240'	6'	10'	177' x 260'
U12		150' x 270'	180' x 300'	6'	10'	192' x 320'
U14		180' X 285'	210' X 330'	6'	10'	222' x 350'
Full Size		180' x 300'	225' X 360'	6'	10'	237' x 380'

Typical Field Programming:

Season

Fall
Winter
Spring / Summer

Program

Football / Soccer
Lacrosse / Rugby
Lacrosse / Soccer

Notes:

- 1) Provide a minimum 12' buffer between double fields. Increase distance whenever possible to accommodate teams.
- 2) Irrigation/drainage system boxes and vaults shall be located outside the field of play whenever possible. This includes side line and end line run out zone. If boxes or vaults are located within these areas, they must be buried a minimum of 4" below grade.
- 3) PCC Rock Creek double field is 510' x 390' w/ 15' side lines and run outs with a 30' buffer between fields.

As a general rule a playing field shall have a minimum safety zone of 6' at side lines and 10' at end lines. Minimum standards may vary depending on site conditions. Synthetic field fencing shall consider adequate space for safety, field uses, spectators, teams and maintenance access. Run outs, side lines and end lines may be adjusted to accommodate property owner standards.

Figure 17

Lacrosse Field Dimensions

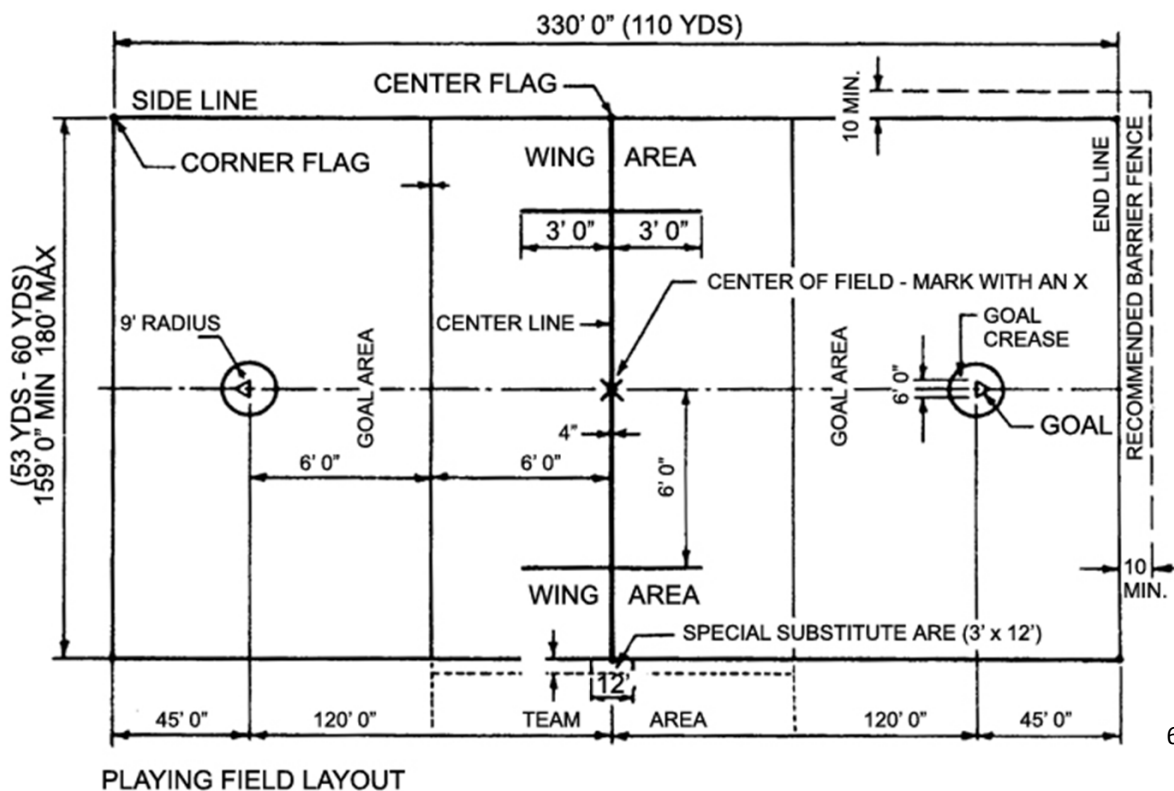

Goal Detail

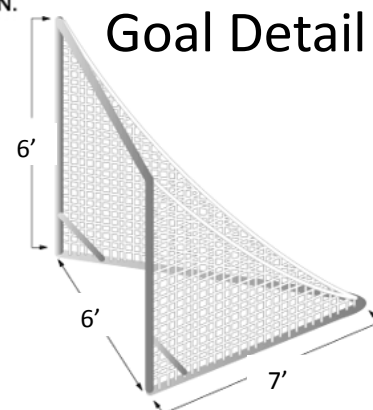

Lacrosse Fields

Field Type	User Group	Minimum Field Size	Optimum Field Size	Side Lines	End Line Run Out	Optimum w/ Run Outs
Small	Boys		150' x 225'	18'	15'	186' x 255'
Preferred	Boys		180' x 330'	18'	15'	216' x 360'
Preferred	Girls	180' x 330'	195' x 360'	13' (4M)	6.5' (2M)	221' x 373'

Typical Field Programming:

Season

Winter
Spring / Summer

Program

Lacrosse / Rugby
Lacrosse / Soccer

Notes:

- 1) Provide a minimum 12' buffer between double fields. Increase distance whenever possible to accommodate teams.
- 2) Both boys and girls lacrosse prefer 15' clear end line run-outs. A full size soccer field can accommodate a girls preferred size if portable soccer goals are pushed back off the field.
- 3) Field design shall include side line space of 18' for spectators and 30' for coaches, table area and teams.
- 4) Irrigation/drainage system boxes and vaults shall be located outside the field of play whenever possible. This includes side line and end line run out zone. If boxes or vaults are located within these areas, they must be buried a minimum of 4" below grade.

As a general rule a playing field shall have a minimum safety zone of 6' at side lines and 10' at end lines. Synthetic field fencing shall consider adequate space for safety, field uses, spectators, teams and maintenance access.

Football Field Dimensions

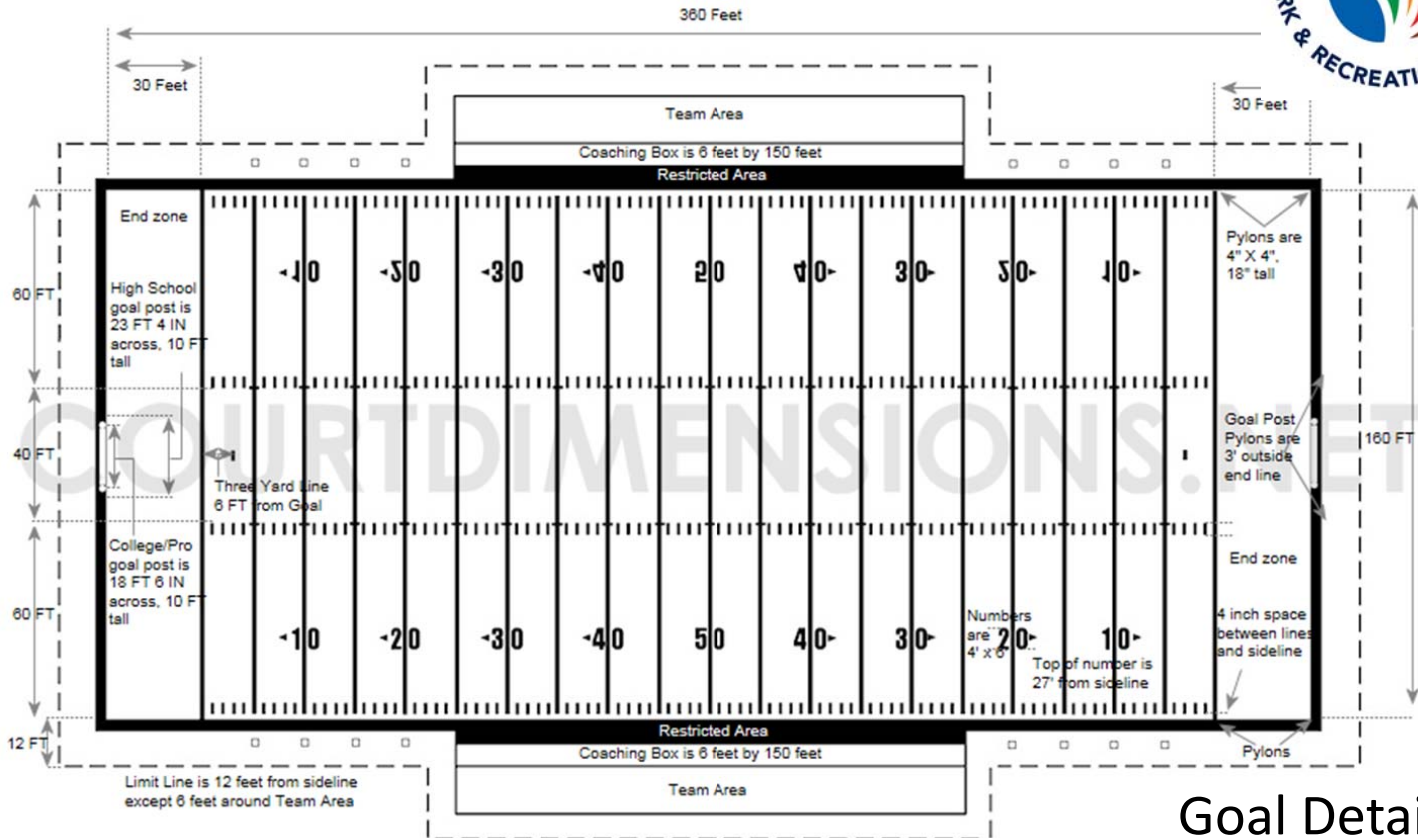

Goal Detail

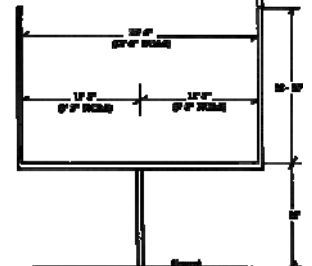

Football Fields

Field Type	User Group	Minimum Field Size	Optimum Field Size	Side Lines	End Line Run Out	Optimum w/ Run Outs
Small Full Size			160' x 360'	6'	12'	172' x 384'

Typical Field Programming: Season Fall Program Football / Soccer

- Notes:**
- 1) Provide a minimum 12' buffer between double fields. Increase distance whenever possible to accommodate teams.
 - 2) Field design shall include space on both sides of the field for spectators and teams.
 - 3) Irrigation/drainage system boxes and vaults shall be located outside the field of play whenever possible. This includes side line and end line run out zone. If boxes or vaults are located within these areas, they must be located a minimum of 4" below grade.

As a general rule a playing field shall have a minimum safety zone of 6' at side lines and 10' at end lines. Synthetic field fencing shall considering adequate space for safety, field uses, spectators, teams and maintenance access. Run outs, side lines and end lines may be adjusted to accommodate property owner standards.

Rugby Field Dimensions

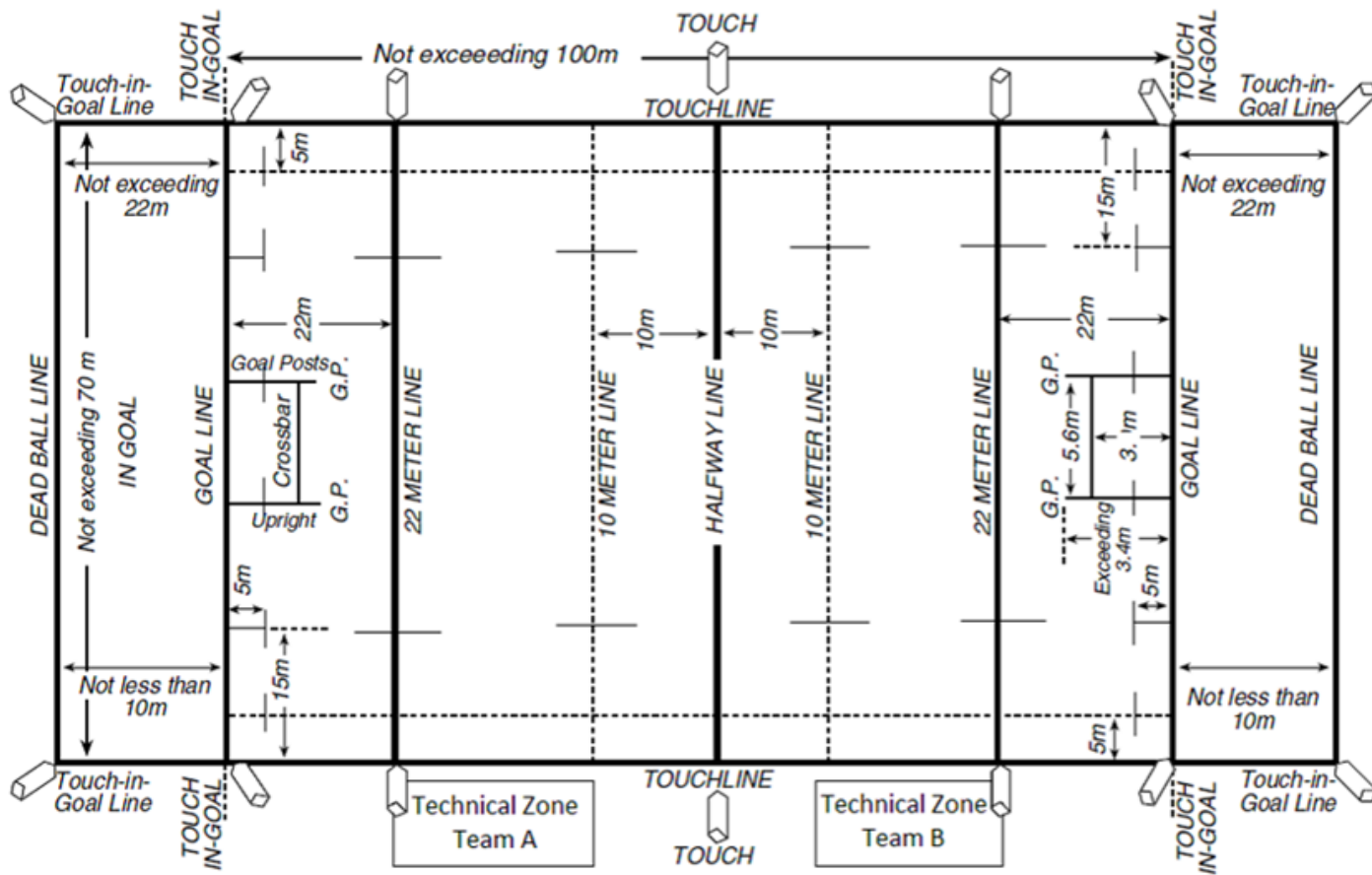

Goal Detail

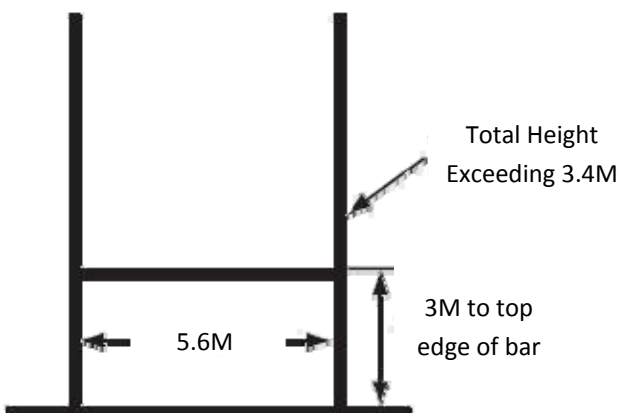

Tennis Court Dimensions

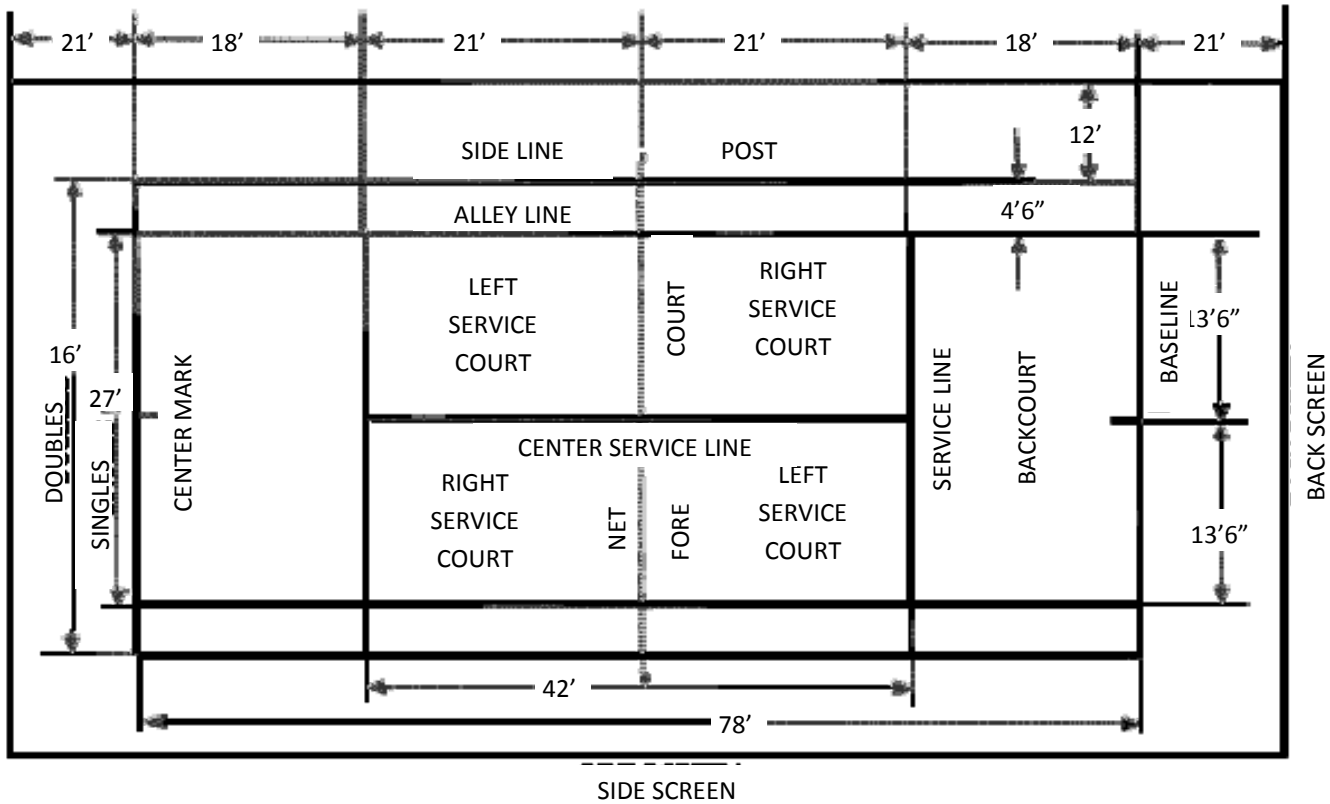

SIDE SCREEN

Net Detail

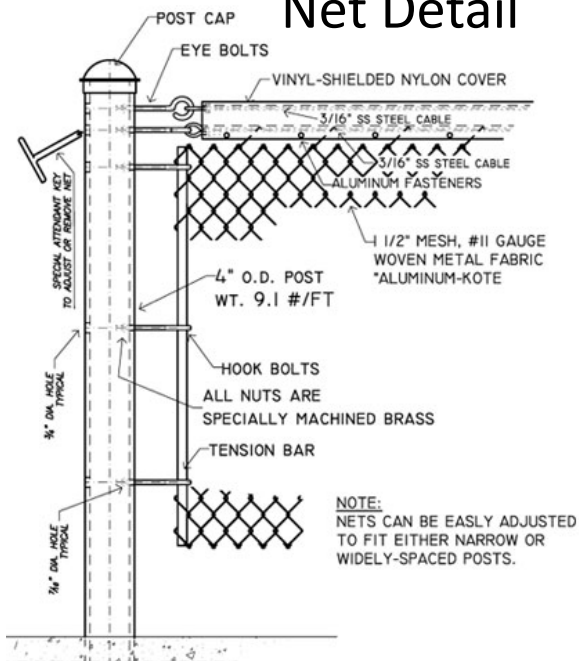
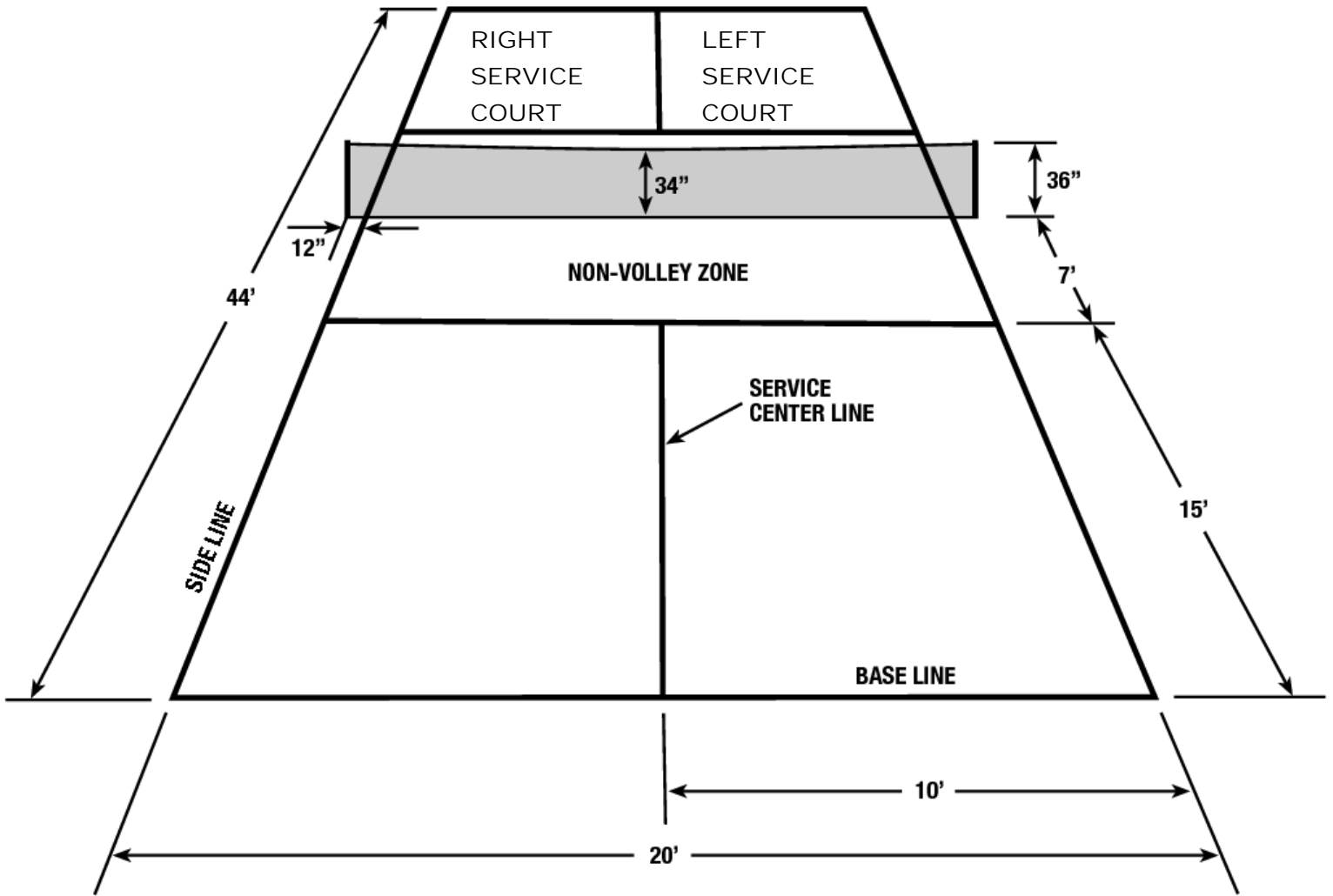
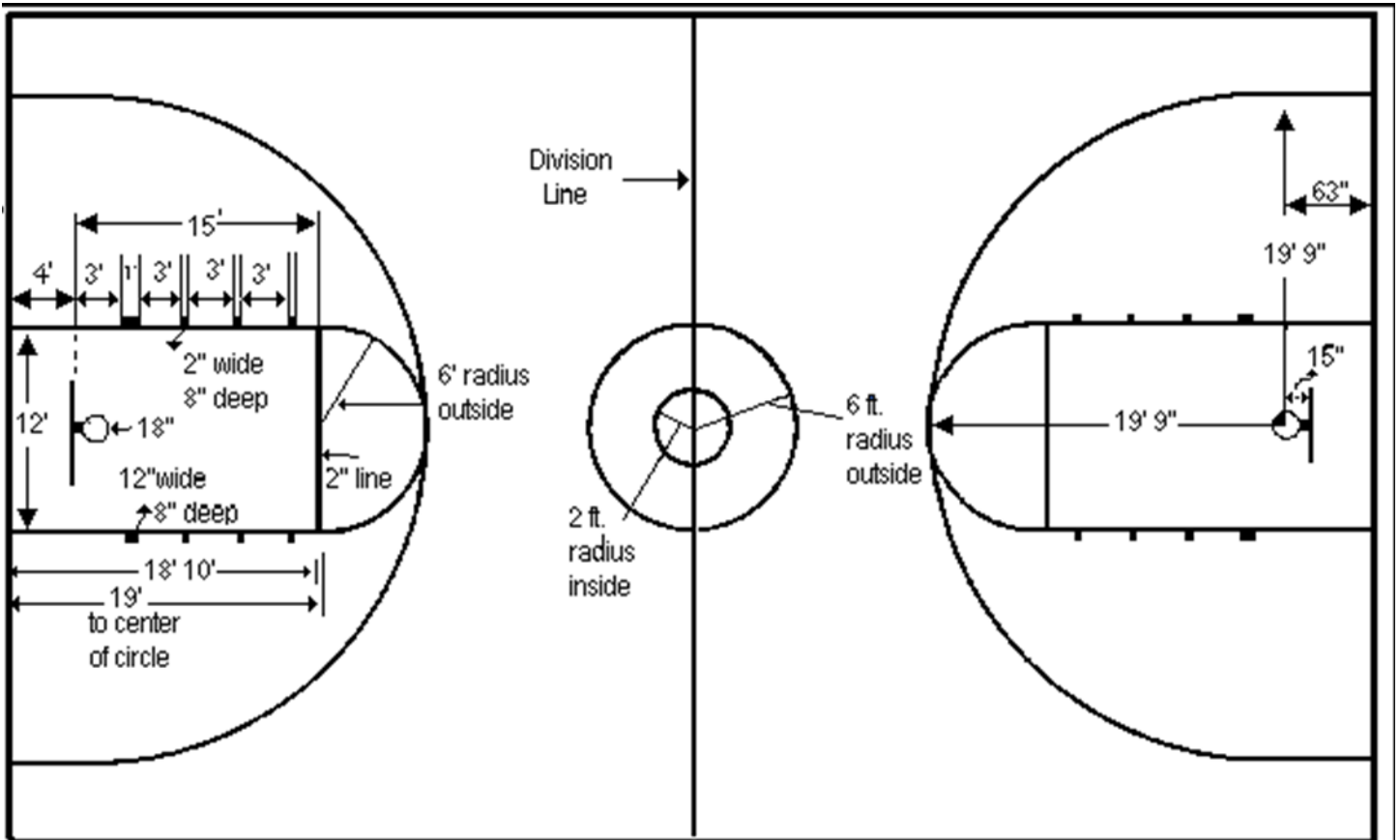

Figure 21

Pickle Ball Court Dimensions



Basketball Court Dimensions



Net Detail

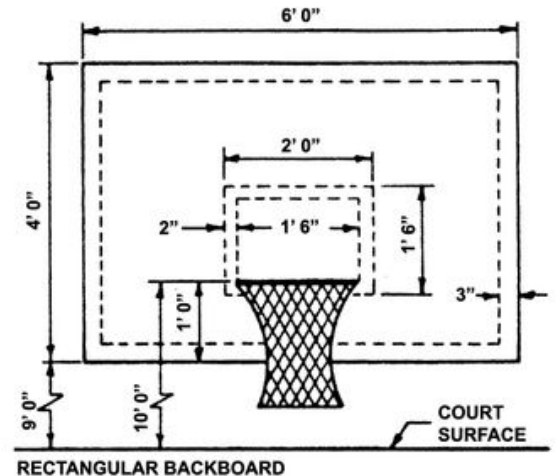
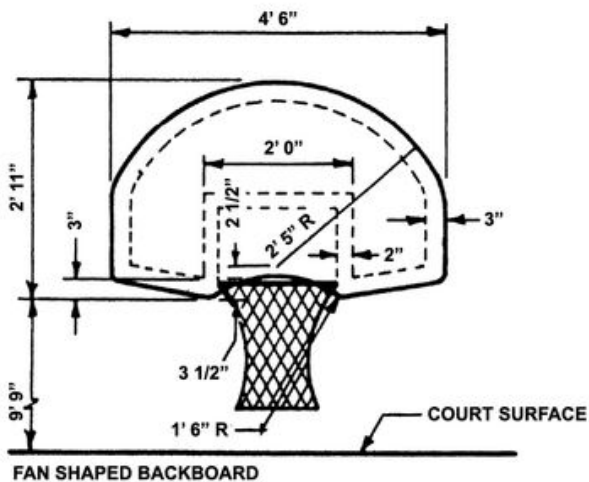

Sand Volleyball Court Dimensions

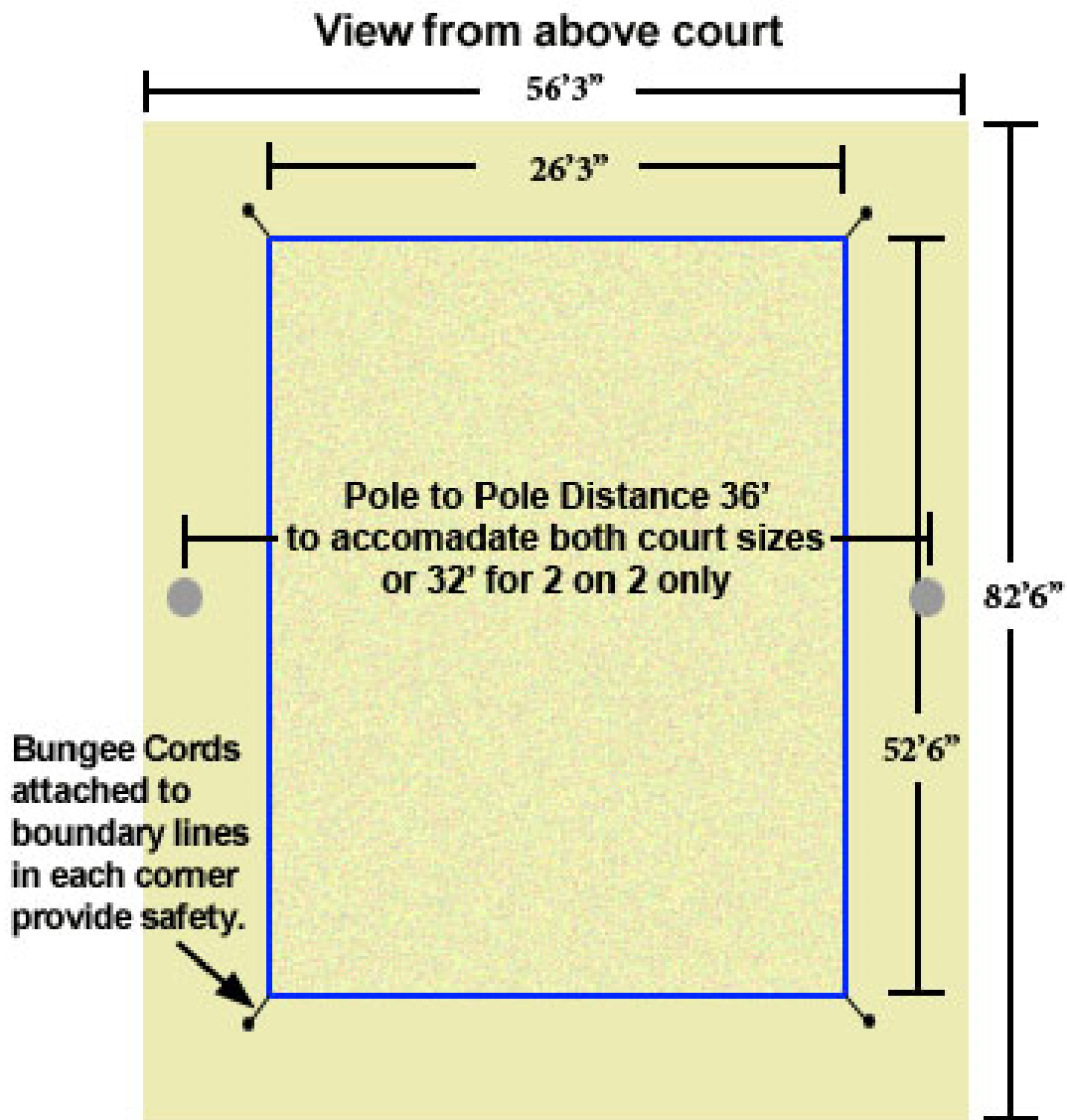

Bocce Court Dimensions

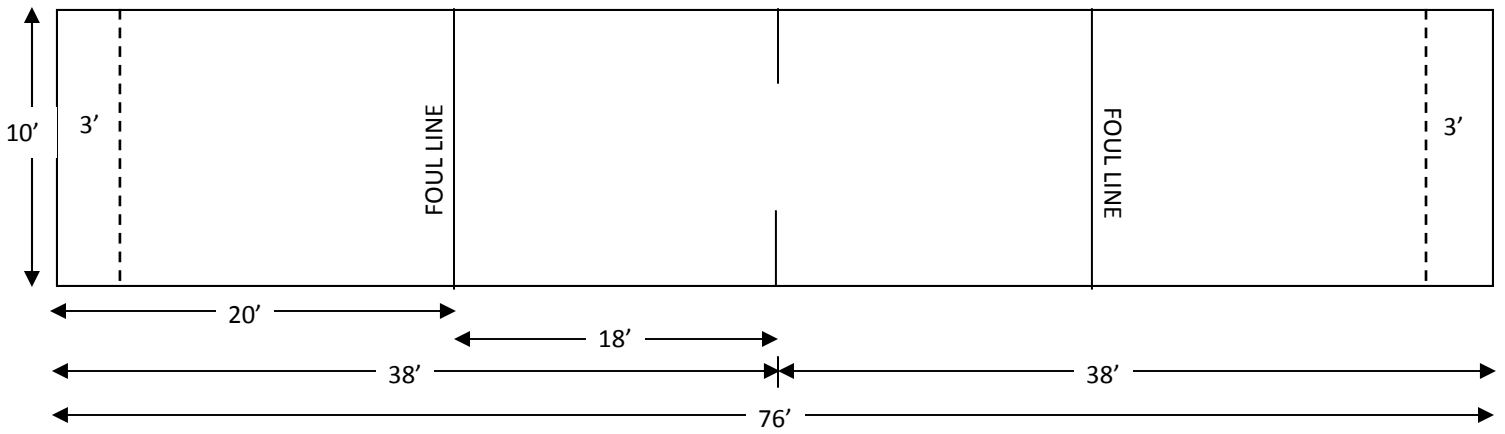

Cricket Pitch Dimensions

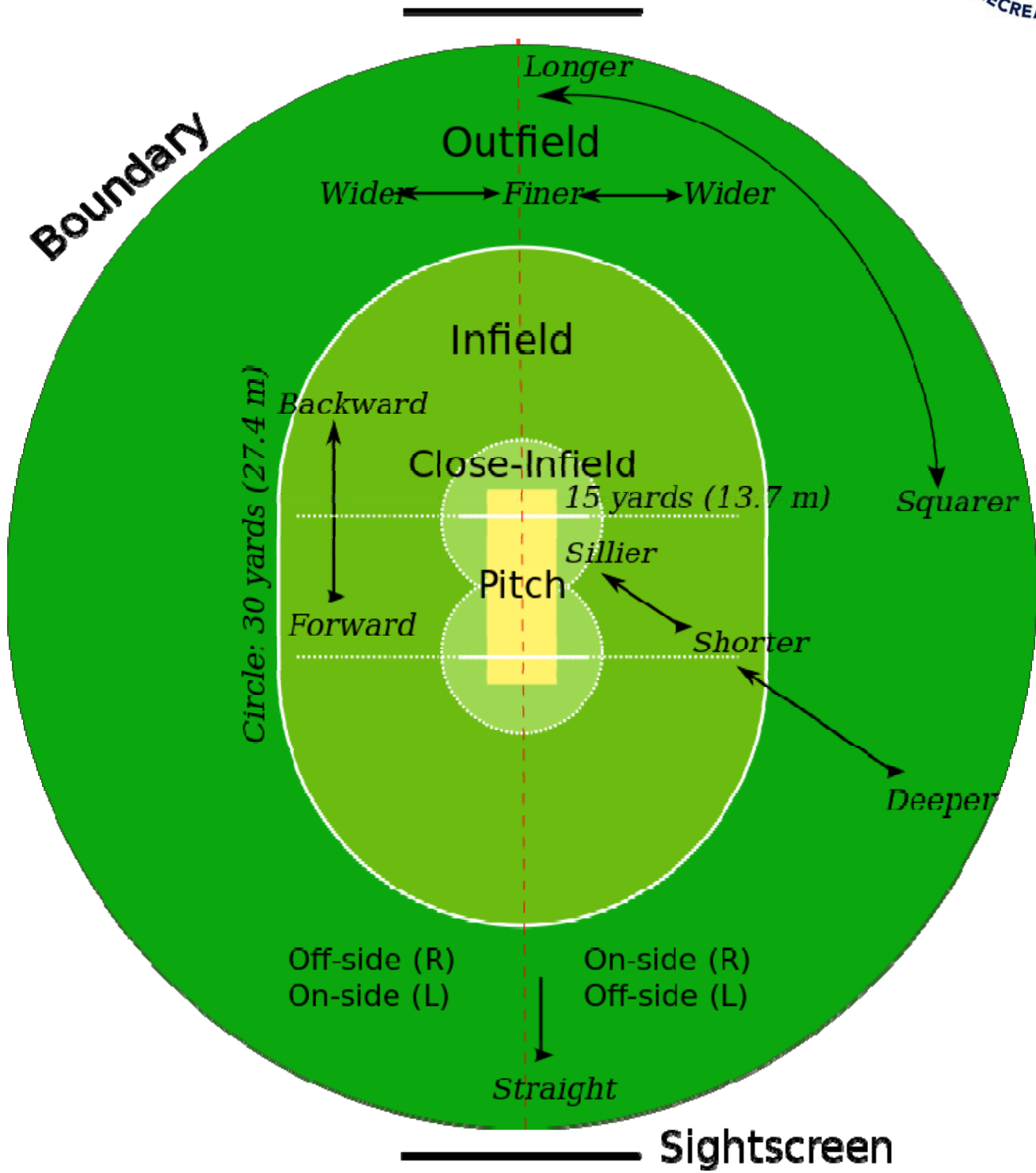

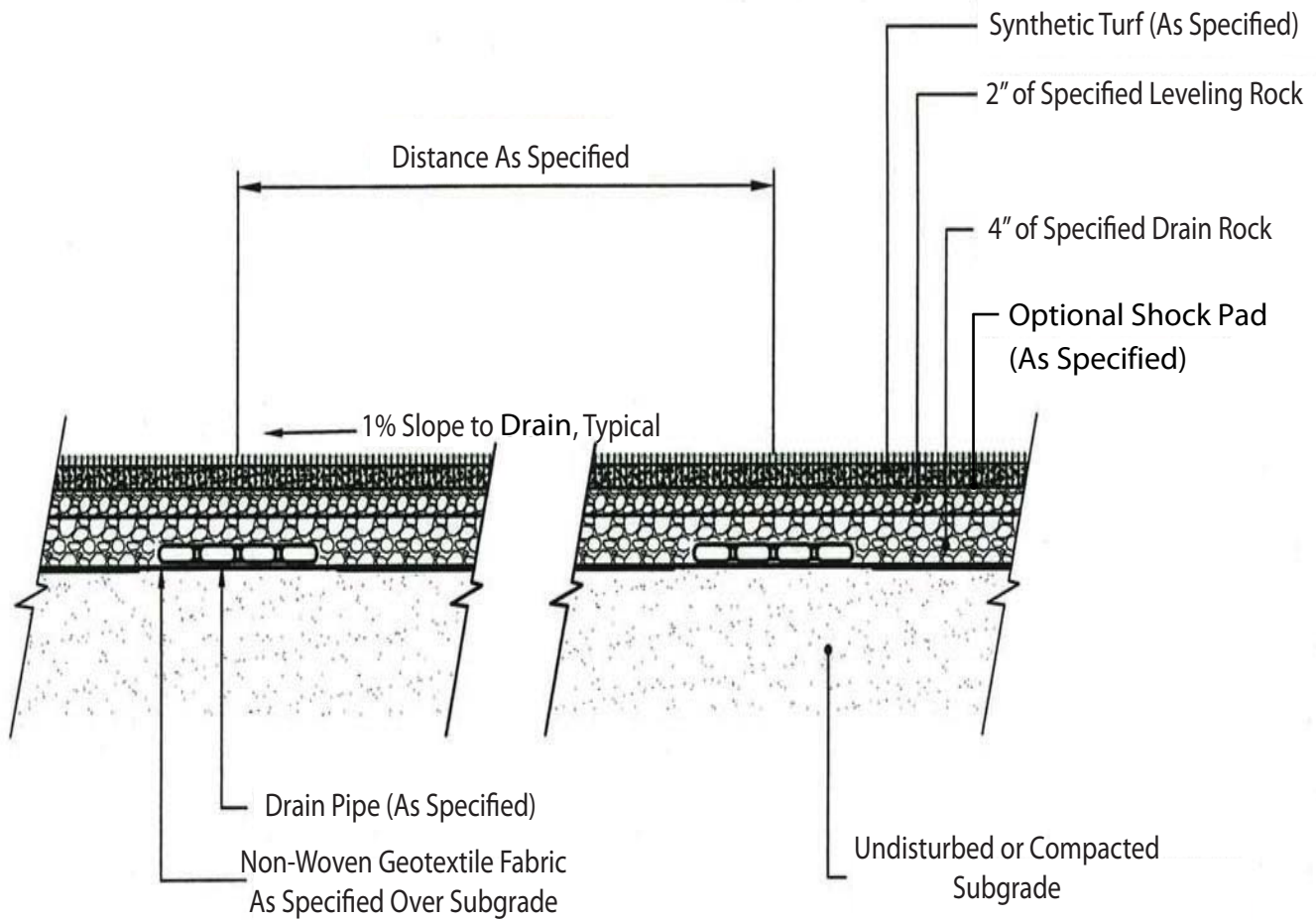

Synthetic Turf Profile

Not to Scale

Note: Current jurisdictional rules require the treatment of storm water that flows through a synthetic turf system prior to being released into a public storm sewer or surface drainage system. Please refer to current jurisdictional code requirements

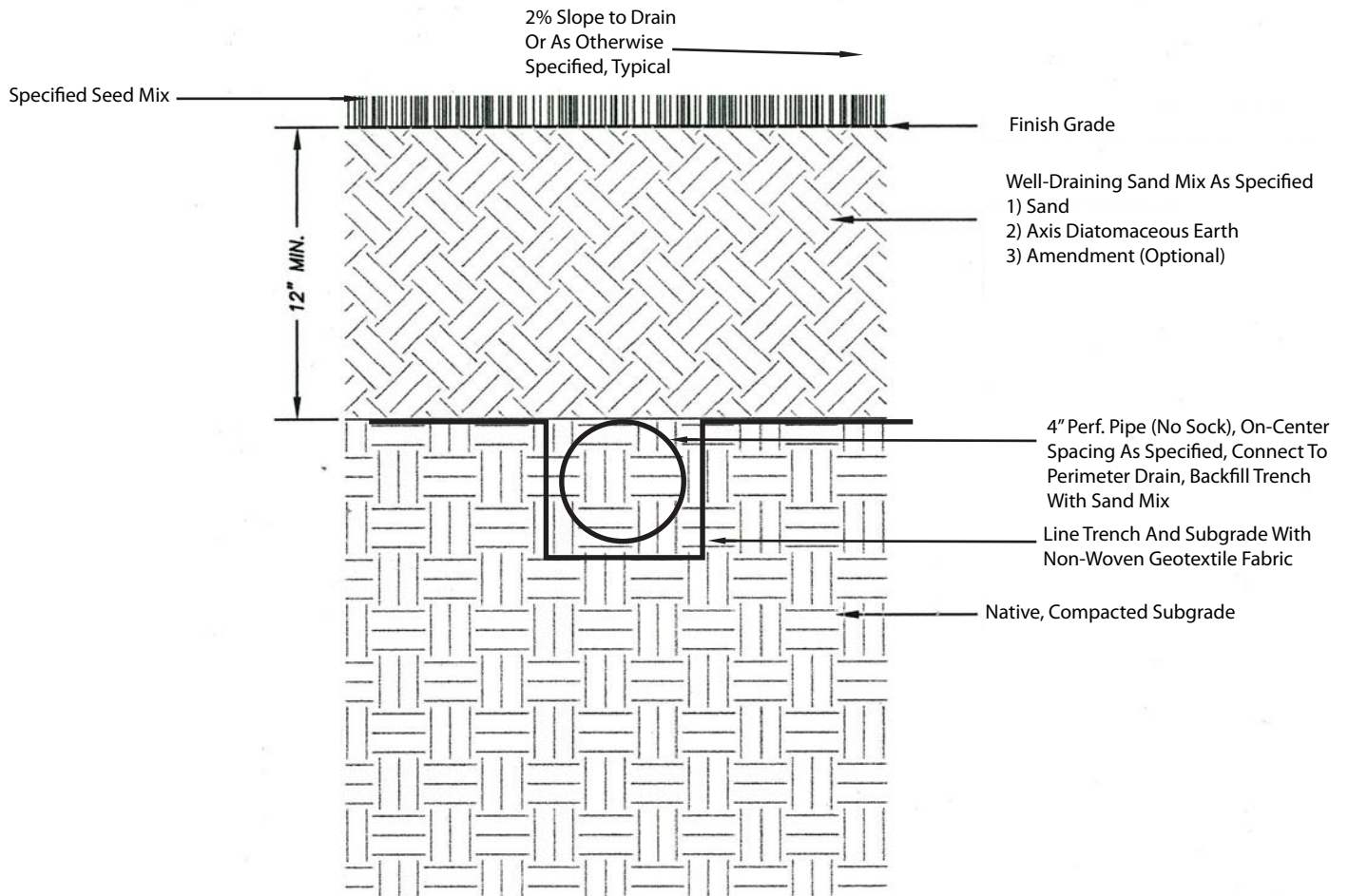

Sand-Base Sports Field

Not to Scale

Note: During the design of all sand-based and native soil grass fields a 2% slope to drain should be provided for improved playing surface drainage.

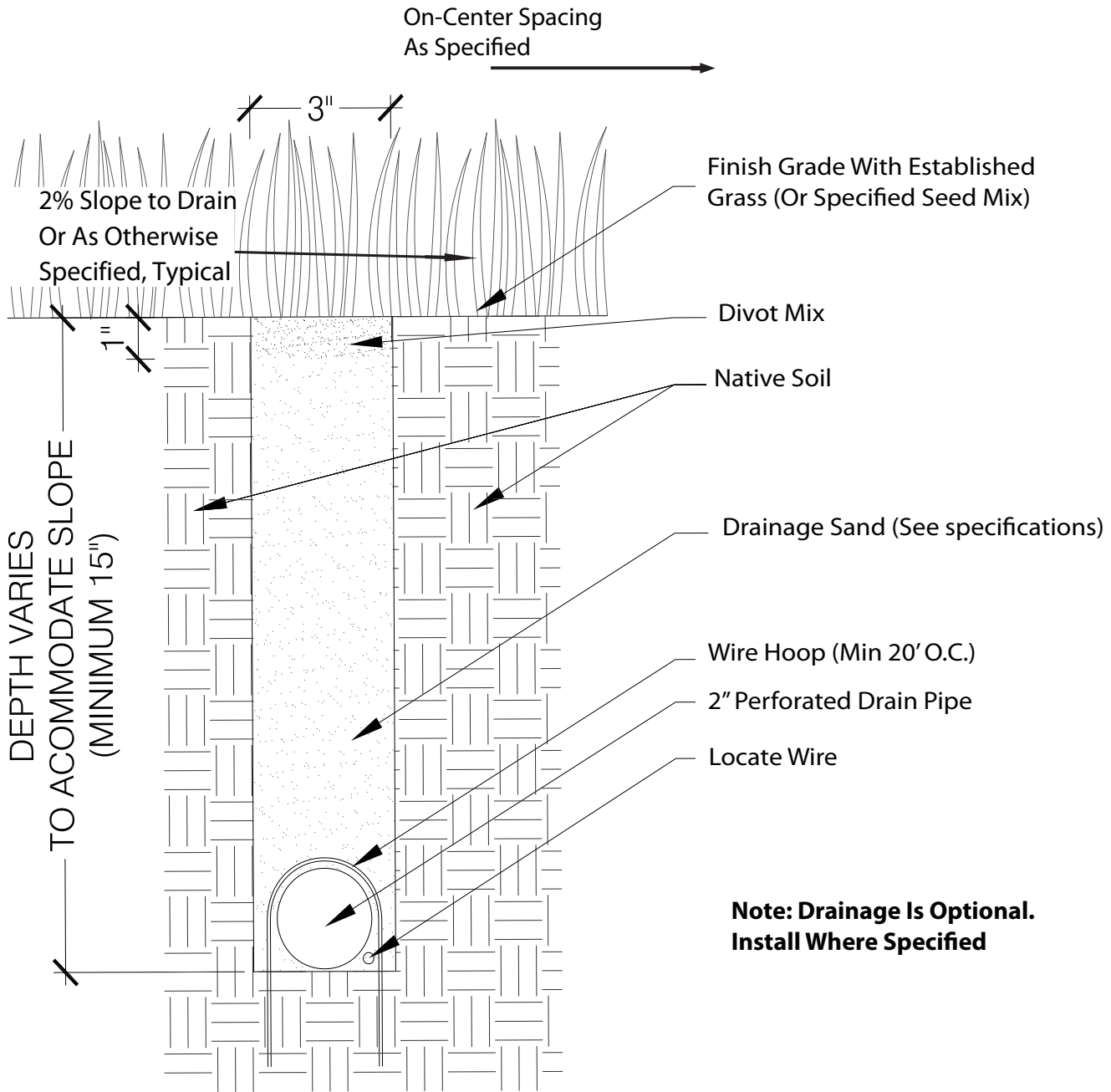

Native Field With Sub-Surface Drainage
Not to Scale

Note: During the design of all sand-based and native soil grass fields a 2% slope to drain should be provided for improved playing surface drainage.

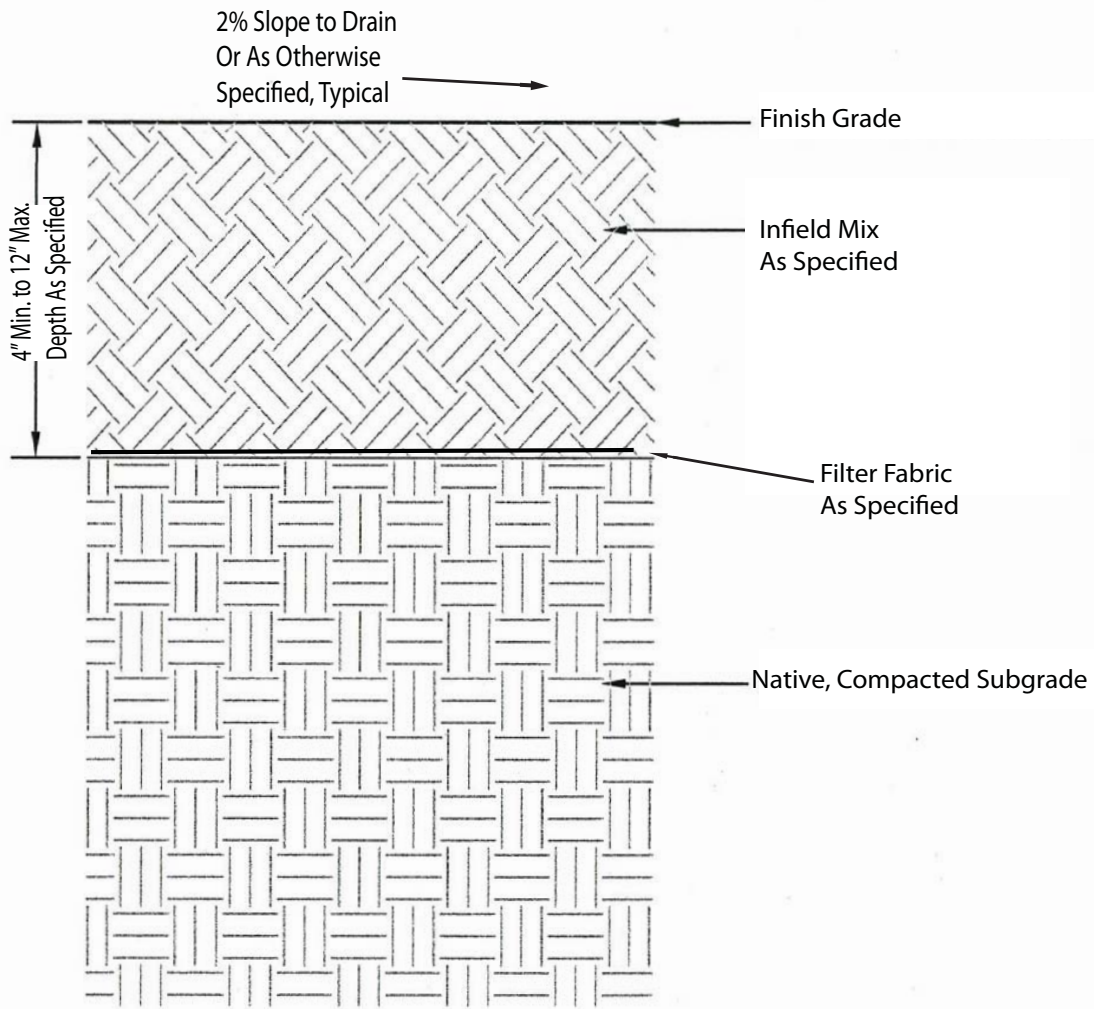

Skinned Clay Infield Detail

Not To Scale

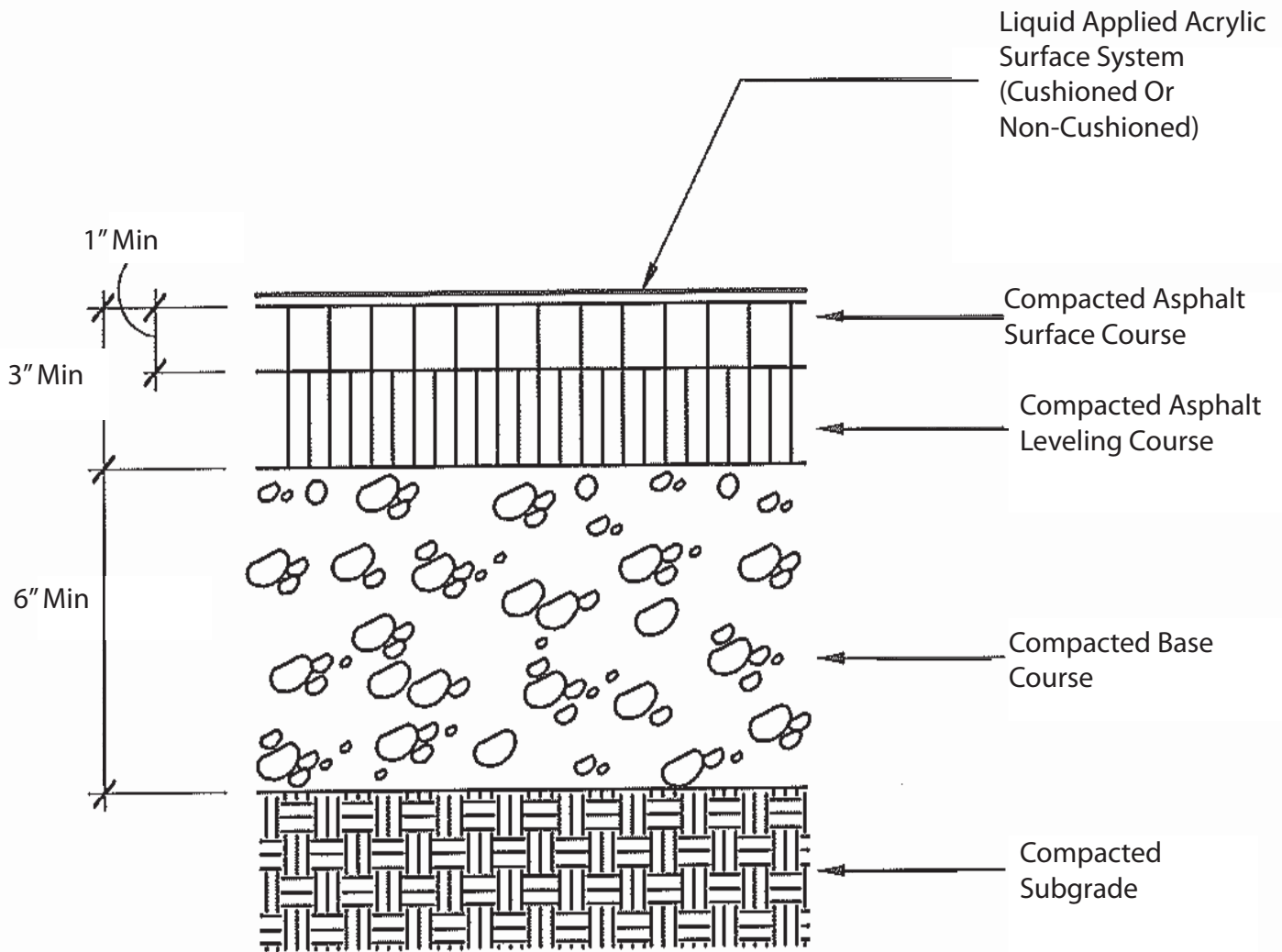

Asphalt Court Sections with Acrylic Surfacing

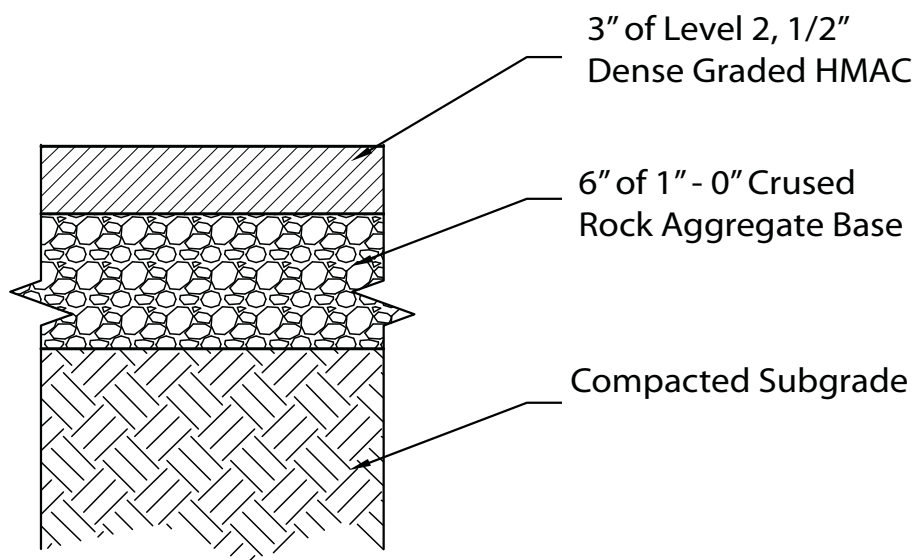

Asphalt Court Section
Not to Scale

Lateral Drainage Configuration

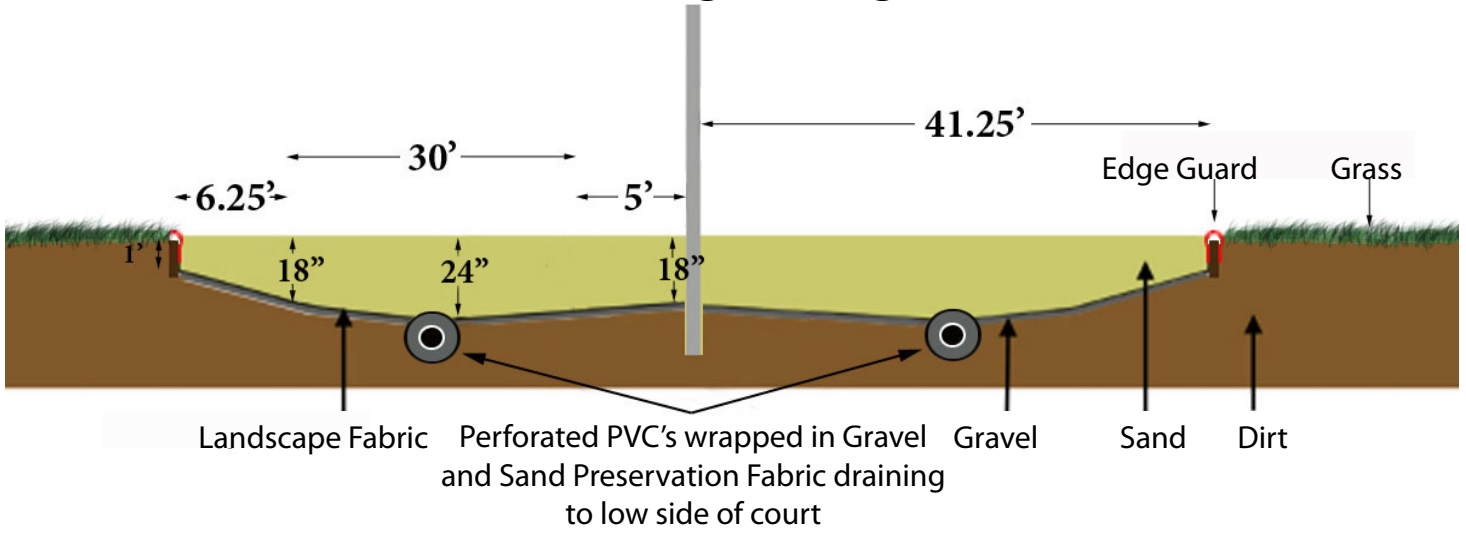

Sand Volleyball Court Section Not to Scale

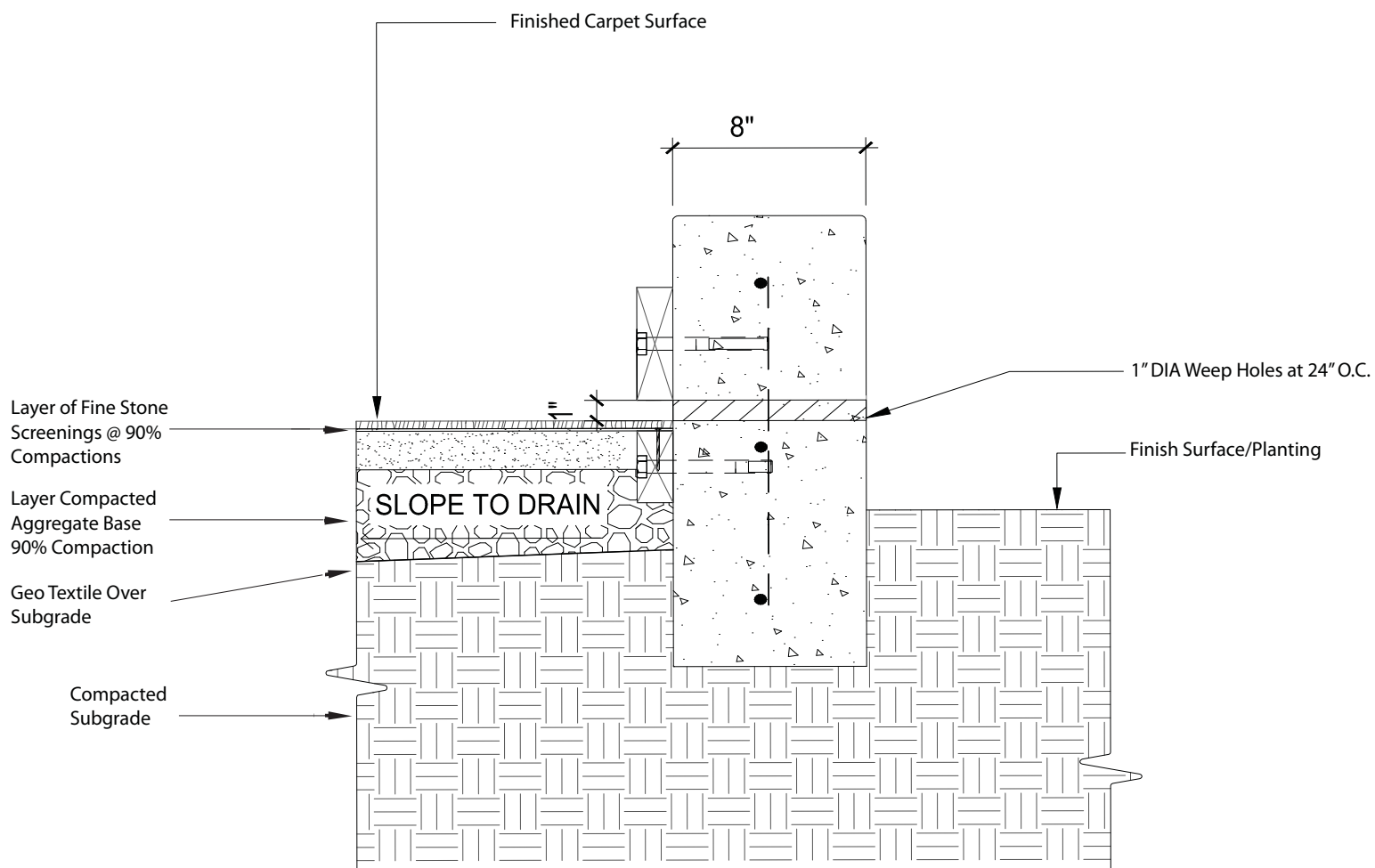

Bocce Court Profile

Not To Scale

Reference Documents

Tualatin Hills Park and Recreation District Comprehensive Plan, 2006

Tualatin Hills Park and Recreation District Comprehensive Plan Update, July 2013

MIG Athletic Field report, executive summary 2004

Tualatin Hills Park and Recreation District Maintenance Standards Manual

Tualatin Hills Park and Recreation District Signage Master Plan

Tualatin Hills Park and Recreation District Parks Functional Plan

Tualatin Hills Park and Recreation District Programs Functional Plan