



TUALATIN HILLS
PARK & RECREATION DISTRICT

TRAILS FUNCTIONAL PLAN

Approved February 2016



ACKNOWLEDGEMENTS

BOARD OF DIRECTORS

John Griffiths, Secretary
Pro-Tempore

Jerry Jones Jr., Secretary

Ali Kavianian, Director

Larry Pelatt, President

Bob Scott, Director

THPRD MANAGEMENT OVERSIGHT

Doug Menke, General Manager

Keith Hobson, Director of
Business & Facilities

Aisha Panas, Director of
Park & Recreation Services

THPRD PROJECT TEAM

Bruce Barbarasch,
Superintendent of Natural
Resources & Trails Management

Tim Bonnin, Senior Park Planner

Mike Fontenot, Park
Maintenance Coordinator

Steve Gulgren, Superintendent
of Design & Development

Brad Hauschild, Urban Planner

Mark Hokkanen,
Risk & Contract Manager

Mike Janin, Superintendent of
Security Operations

Gery Keck,
Facilities & Project Manager

Nicole Paulsen, Design &
Development Coordinator

Jeannine Rustad,
Superintendent of Planning

Keith Watson,
Park Maintenance Supervisor

PLAN REVIEWERS

THPRD Advisory Committees
(Parks, Natural Resources, Trails)

Metro Trails and
Greenspaces Staff

Washington County Land Use &
Transportation Staff

City of Beaverton Transportation
Planning Staff

CONSULTANT

Katie Mangle,
Alta Planning + Design

TABLE OF CONTENTS

Executive Summary5

Introduction9

Existing Conditions / Where We Are 13

Achieving Success / What We Want To Be.....37

Implementation & Development / How We Get There 75

Success Monitoring / How Are We Doing.....85

Appendix..... 91





EXECUTIVE SUMMARY

The purpose of the Trails Functional Plan (TFP) is to support implementation of the Tualatin Hills Park & Recreation District's (THPRD) 2013 Comprehensive Plan Update. This plan sets forth THPRD's approach to providing, developing and maintaining trails for its patrons. This TFP outlines how the district acquires land for trails and prioritizes new trail development and existing substandard trail enhancement.

This plan replaces the 2006 Trails Master Plan. It updates the district's existing trails inventory and makes new recommendations for the trail framework. The TFP will help THPRD maintain overall level of service (LOS), improve walkable access to trails, establish criteria for how land is acquired for trails and establish prioritization criteria for trail development and enhancement.

This plan consists of four primary sections:

- » Existing Conditions
- » Achieving Success
- » Implementation & Development
- » Success Monitoring

EXISTING CONDITIONS

Where We Are



This section of the TFP includes refinement to the district's trail classification system that further clarifies the intent of regional, community and neighborhood trails as well as other types of facilities (e.g., shared use pathways, sidewalks, etc.). It also establishes new design standards for regional (12 feet wide), community (10 feet wide) and neighborhood (6-8 feet wide) trails. Guidance is also provided on administering trail counts and provides locational criteria for counter placement as well as describing the types of mid-block crossing options available, and their design elements.

The TFP identifies a number of trail planning partners the district should actively engage with to further its trail system. This includes agencies such as the Oregon Parks & Recreation Department, the Oregon Department of Transportation, Metro, Washington County, the City of Beaverton and those cities neighboring the district's service area. The plan also identifies utility agencies, such as the Bonneville Power Administration, Portland General Electric and Clean Water Services, as being partners in trail design and development.



A major component of this section of the plan is the identification of the district's trail system and the individual segments that make up each individual trail. A number of tables highlight those segments completed and those segments remaining to be constructed. Additional tables highlight new trails that need to be planned, especially in new urbanizing areas of the district like South Cooper Mountain and Bonny Slope West.

ACHIEVING SUCCESS

What We Want To Be

The TFP establishes trail standards for the district's trail classifications (regional, community, neighborhood) as well as standards for trails occurring in unique situations (trails adjacent to roadways, trails combined with sidewalks, trails in greenways). This plan also includes a number of design standards and guidelines covering a variety of topics such as accessibility, utilities, surfacing, amenities (site furnishings, bollards, signage, etc.), bridges and boardwalks and safety and security. Additionally, guidance is provided for maintenance and operation of trail facilities.

IMPLEMENTATION & DEVELOPMENT

How We Get There

The TFP identifies criteria that will be used to prioritize trail enhancement and development. These include, but are not limited to: level of community support, project location in an underserved area and whether or not it overcomes barriers. As projects arise, they will be scored and placed in Tier I (high) or Tier II (medium) priority categories. These criteria will also be used for determining site suitability for land acquisition of new trail corridors.

In addition to the criteria identified in this plan, future trails to be located along creek corridors or other natural areas, such as the Beaverton Creek, Bronson Creek and Willow Creek Trails, will also be evaluated using site development suitability criteria identified in the district's Natural Resources Functional Plan (NRFP). These trails are identified as future study areas on the updated trail system map, incorporated within this TFP.

A number of funding sources are identified for trail development and enhancement projects, such as capital funds, system development charges (SDCs), grants, partnerships and general obligation bonds. Not all funding sources can be used for all types of trail improvements.

SUCCESS MONITORING

How Are We Doing

The TFP identifies a number of performance measures for trails, which are typically monitored annually and include, but are not limited to: miles of new trails completed, miles of existing trails enhanced and number of trail users counted. Trail user profiles, and access to target populations will be monitored to help ensure equitable access to trails throughout the district's service area.

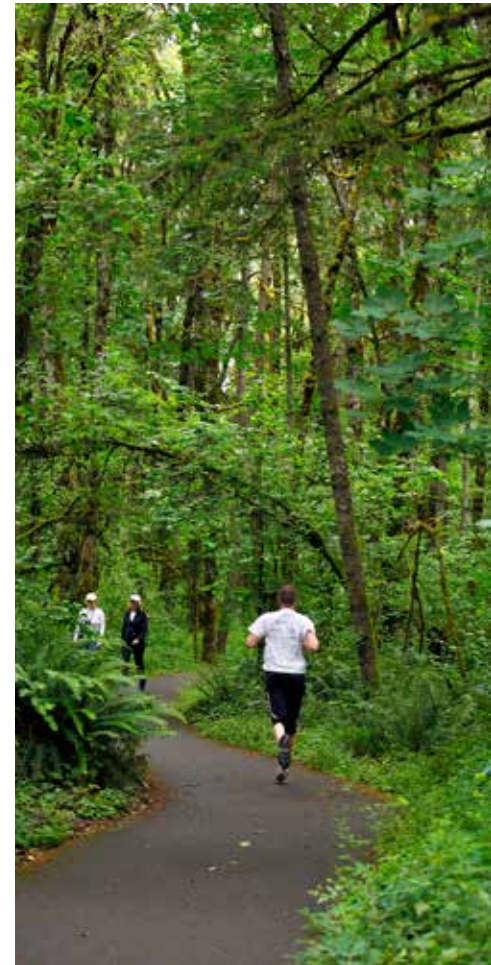

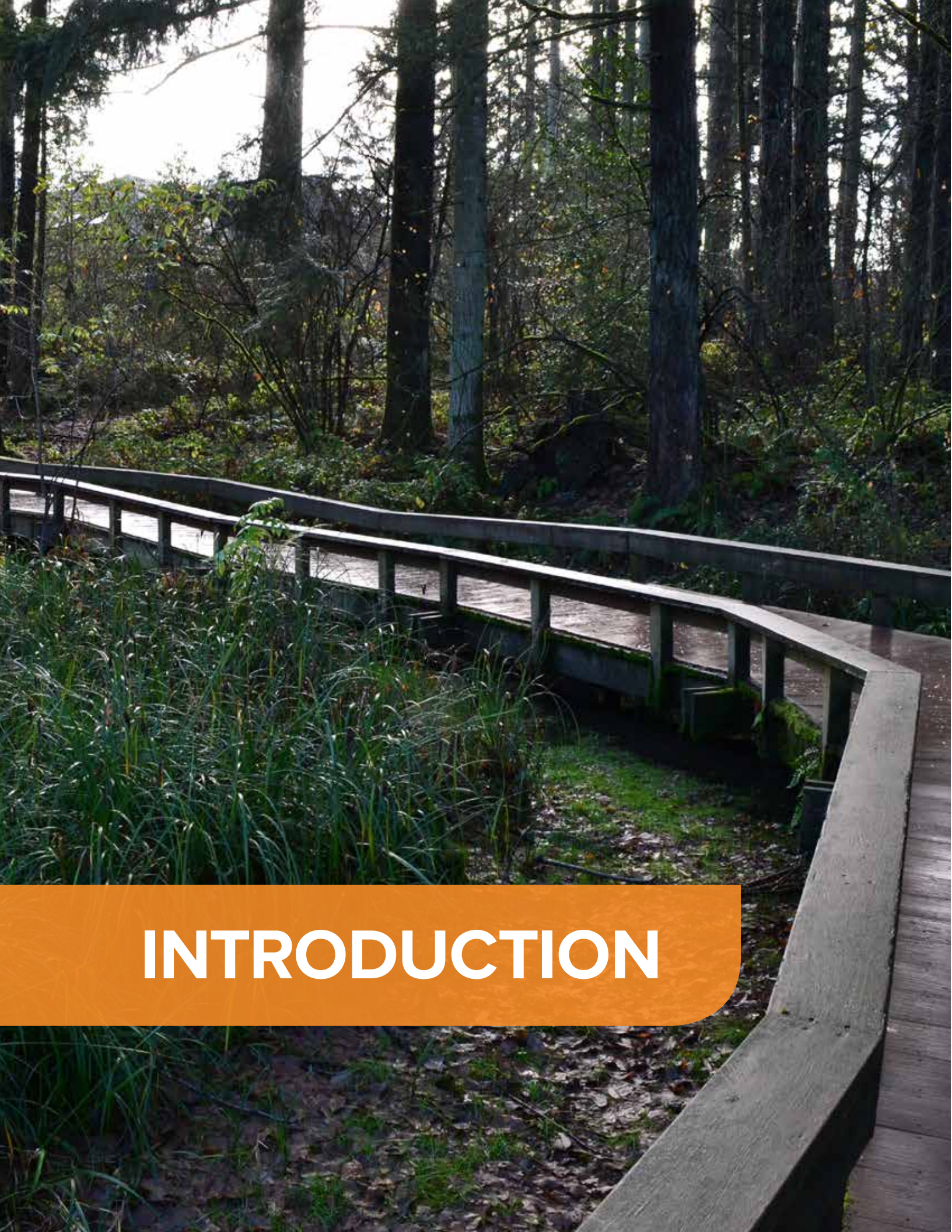

INTRODUCTION

The district's 1998 Trails Master Plan, updated in 2006, recommended improvements to the existing trail system; completion of missing gaps; and connections to significant environmental features, schools, parks and recreation, public facilities, transit, local neighborhoods and business centers throughout the region.

The Trails Master Plan also listed eight goals:

- » Providing recreation opportunities
- » Trail development and regional connections
- » Access
- » Community linkages
- » Amenities
- » Maintenance and emergency access
- » Preservation
- » Funding

This TFP replaces the 2006 Trails Master Plan. It updates the district’s trails inventory and incorporates the eight goals. This TFP also identifies new recommendations for the district’s trail framework. While this TFP replaces the 2006 Trails Master Plan, which replaced the 1998 Trails Master Plan, it builds upon the progress made since these previous plans were adopted and sets a vision for future success.

The purpose of the TFP is to outlines how THPRD:

- » Acquires land for trails
- » Prioritizes new trail development
- » Upgrades existing substandard trails

The following goal identified in the 2013 Comprehensive Plan Update relates to providing, developing and maintaining trails for its patrons:

- » Goal 5 “Develop and maintain a core system of regional trails, complemented by an interconnected system of community and neighborhood trails, to provide a variety of recreational opportunities such as walking, biking and jogging.”

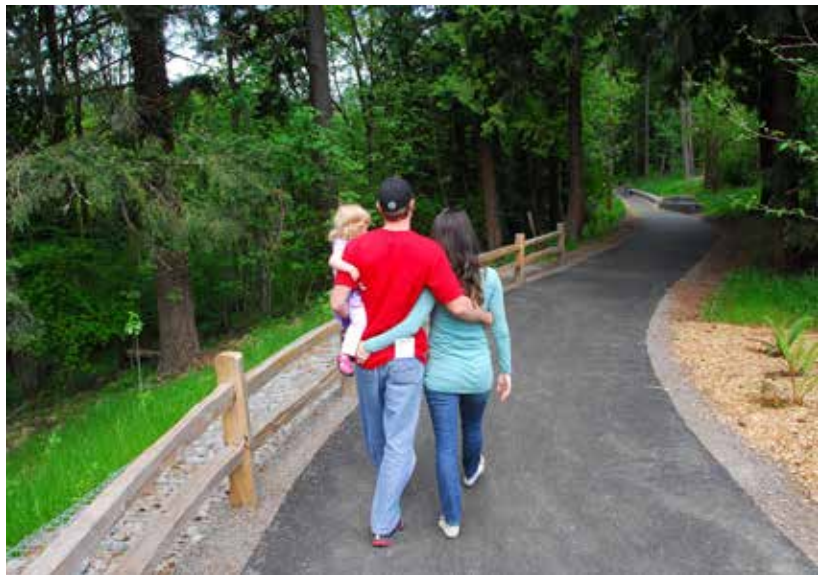

In addition to providing recreational opportunities for district residents, it is recognized that trails also provide transportation opportunities to transit – both bus and light rail – for bicycle commuters.

An outcome of THPRD’s Comprehensive Plan Update process and the 2013 Comprehensive Plan Update was a call for a review of the standards and guidelines used to ensure residents are provided with quality facilities, such as trails, parks and natural areas. This review included land acquisition procedures for trails, development or enhancement of trails and maintenance and operation of trails.

This plan will help the district:

- » Maintain overall level of service (LOS) to the residents it serves
- » Improve walkable access to trails and other district facilities
- » Establish update criteria for how land is acquired for trails
- » Establish prioritization criteria for new trail development and enhancement of existing substandard trails





EXISTING CONDITIONS

THPRD first adopted a trails master plan in 1998. In 2006, that plan was updated (as part of the comprehensive plan update) and identified a number of goals for trails; established a trail classification system; created standards for trails, land acquisition and maintenance; and provided strategies for achieving success. The 2006 Comprehensive Plan was updated in 2013, refining district goals and rethinking strategies on goal implementation, including the establishment of this TFP. This section of the TFP takes a look at where the district sits today and its progression since the 2006 update.

3.1 GENERAL DESCRIPTION / OVERVIEW

3.1.1 Bond Survey Results

As part of the district's 2008 bond initiative, a survey was conducted to determine what facilities are most important to residents. Development of new trails and completing gaps in the existing trail system were at the top of the list. Surveys completed in 2012, 2014, and 2015 as part of the 2013 Comprehensive Plan Update, Parks Functional Plan (PFP) and this TFP also confirmed that trails and access to trails rate high in importance to district residents for both recreational and commuting purposes.

3.1.2 Trail Descriptions and Classifications

The following trail descriptions are intended to provide a broader overview of the types of trails and linkages that can be found within THPRD's service area. Trails within the service area are varied and occur in many different types of environments and situations. This includes trails that are more urban, occupying roadways, sidewalks, other rights of way and trails that may switch from a designated paved, multiuse trail onto a shared sidewalk/trail, to weave through the surrounding urban infrastructure. Some trails may be more natural or remote or follow utility corridors or greenways.



3.1.2.a Regional Trail

A regional trail is defined by its length, multi-jurisdictional alignment and connection to regionally significant features. Regional trails connect residents within the district to adjacent communities like Hillsboro, Tigard, Portland, unincorporated Washington County and the greater Portland metropolitan region. These trails also connect to regionally significant features such as the Tualatin Hills Nature Park, the Jenkins Estate and the Howard M. Terpenning Recreation Complex. In addition to providing recreational opportunities, regional trails often serve as transportation corridors because of the regional connections they make to transit, civic places, employment and commercial centers, and residential neighborhoods. Typical characteristics of regional trails include:

- » Accommodating two-way non-motorized bicycle and pedestrian traffic, typically being 12 feet wide
- » Being located in its own right of way separated from roads and streets
- » Being paved with gravel shoulders
- » Accommodating smaller maintenance and emergency vehicles when possible

3.1.2.b Community Trail

Community trails link important destinations between neighborhoods and across the district to parks, natural areas, schools, trails, transit and shopping centers. They function as both recreation and transportation corridors for a variety of users. Typical characteristics of community trails include:

- » Accommodating two-way non-motorized bicycle and pedestrian traffic, typically being 10 feet wide
- » Being located in its own right of way separated from roads and streets
- » Being paved with gravel shoulders
- » Potentially being designed to function as a regional trail when high trail use is anticipated
- » Accommodating smaller maintenance and emergency/security vehicles when possible



3.1.2.c Neighborhood Trail

Please note that the 2006 Trails Master Plan identified both urban and neighborhood natural trails in its trail classifications. With this TFP, natural neighborhood trails have been re-classified as soft “surface pathways.” These types of trails are primarily site specific to parks or natural areas and do not extend beyond these areas. Information on design considerations for these types of pathways can be found in the district’s PFP and the NRFP. With this TFP, urban neighborhood trails have been re-classified as neighborhood trails and are described below.



Neighborhood trails provide short distance connections to local features such as parks, natural areas, community centers, schools and other neighborhood attractions. Where they provide a direct connection, neighborhood trails will generally have their own right of way, separated from the street system. In other cases, they may consist of on-street segments with patrons using existing sidewalks for pedestrians and bike lanes or residential streets for bicyclists. These trails are often walking and hiking trails from regional or community trails and public right of ways, but many may also be located within parks or natural areas. Typical characteristics of neighborhood trails include:

- » Not always accommodating two-way non-motorized bicycle and pedestrian traffic, typically being 6-8 feet wide
- » Being located on- or off-street, with or without its own right of way and separated from roads or streets
- » Being paved or unpaved, usually without gravel shoulders
- » Not always being fully accessible because neighborhood trails can include staircases or be located on steep slopes due to site topography

3.1.2.d Additional Definitions

- » Trail: a designated land corridor that provides a marked route with little interruption in travel
- » Shared Use: shared by pedestrians (including dog walkers), bicyclists, skaters, joggers and other non-motorized users
- » Unpaved/Natural Surface: a surface consisting of gravel, crushed rock, soil, or other semi-pervious material
- » Sidewalk: a paved walkway along the side of a roadway separated from the roadway by a raised curb and/or planter strip; located within the public right of way
- » Bike lane: a portion of the roadway, usually an arterial or collector, that has been designated by striping, signing and pavement markings for the preferential or exclusive use of bicyclists; located within the public right of way

3.1.3 Trail Counters

THPRD manages a trail user count program that relies on passive infrared counters at fixed locations, collecting hourly usage. The information is collected monthly for analysis in daily, weekly, monthly and annual reports. Based on district staff calibration, the trail counters are highly accurate. Several counters can be found along the same trail to determine heavier use areas. Also, multiple counters along the same trail can help to track changes over time, such as a before and after the addition of a new trail segment, installation of a mid-block crossing, or providing new directional signage. It should be noted that increases or decreases in trail use can vary depending on a whole host of variables, including weather and time of year.



3.1.3.a Trail Counts

The district uses a number of trail counters along many of its regional and community trails. Trail counters are also used along pathways or nature trails internal to park sites and natural areas. As described previously, the purpose of using trail counters is to gauge trail usage and track trail user trends. At the time of this TFP adoption, trail counters are located at the following regional and community trail locations (see Appendix 7.3 for counts collected from 2010-2015). Information collected does show a trend for increasing trail use each year, especially on those trails where gaps have been completed, such as on the Fanno Creek Trail and Westside Trail.

- » Fanno Creek Regional Trail at Scholls Ferry Road
- » Fanno Creek Regional Trail at Hall Boulevard
- » Fanno Creek Regional Trail at 92nd Avenue
- » Rock Creek Regional Trail
- » Waterhouse Trail (North) at Walker Road
- » Waterhouse Trail (South) at Walker Road
- » Westside Regional Trail at Murrayhill
- » Westside Regional Trail at Village Lane

3.1.3.b Trail Counter Location Criteria

As new trails are planned and completed, the location of trail counters is important to ensure appropriate trail usage data is collected. Locations selected for long- and short-duration data collection should focus primarily on those trail sections most representative of prevailing user patterns (not necessarily at landmarks or other areas that might skew data collection).

For fixed counters, which are what the district uses, the following considerations should be kept in mind:

- » Locate on straight, level sections of trail, not on curves or on/near a steep grade
- » Locate on smooth pavement or other compacted surface
- » Locate at potential improvement areas, such as mid-block crossings, gaps, pinch points and locations that are operationally difficult for bicyclists and pedestrians to navigate, to gauge impacts of future improvements
- » Avoid locating near water or in direct sunlight
- » Avoid placement that directly faces roadways unless a vertical barrier exists
- » Avoid locating near high-power utility lines that could disrupt or distort the detection capability

The Natural Resources & Trail Management department is responsible for locating trail counters and collecting trail count data. Prior to installation, coordination with the appropriate district staff is needed to determine a precise trail counter location.

3.1.4 Trail Planning Partners

The district is primarily concerned with the off-street trails network. On-street connections between trails, parks, natural areas, schools, transit and other community destinations are the primary responsibility of the City of Beaverton and Washington County. However, partnership and cooperation between the district, city and county is essential when providing or enhancing existing on-street connections to adequately serve users. This includes coordination between this plan and the transportation plans of each respective agency.

Within THPRD's service area, other jurisdictions are responsible for permitting development through the land use and development approval process. The land use ordinances of Beaverton and Washington County provide both jurisdictions the ability to require land dedication and on-site development of trails during the development review process. Trails included in each jurisdiction's Transportation System Plan (TSP) may be incorporated through the site planning and land division application review process.

In addition to working with the city and county, other agencies can offer guidance for trail planning and development. Table 3A provides an overview of these partner agencies.

TABLE 3A TRAIL PLANNING PARTNERS

Trail Partner	Description
Oregon Parks & Recreation Department (OPRD)	<ul style="list-style-type: none"> » Statewide recreational trails planning and development agency » Provides technical assistance for trail design and development » Provides funding for trail development and construction through state and federal grant programs » Supports bicycle and pedestrian tourism » Coordinates with ODOT to ensure compatibility between trails and transportation
Oregon Department of Transportation (ODOT)	<ul style="list-style-type: none"> » Statewide transportation planning and development agency » Provides technical assistance for trail design and development whenever located within a state right of way or on federally funded trail projects » Provides funding for trail design and development through state and federal grants and funding programs » Coordinates with OPRD to ensure compatibility between trails and transportation
Metro	<ul style="list-style-type: none"> » Regional trails and transportation planning agency, including the regional trails and greenspaces the plan, regional transportation plan and the regional active transportation plan » Provides technical assistance for trail design and development » Provides funding for trail planning, design and development through regional and federal grants and funding programs » Coordinates with state and local agencies to ensure compatibility between trails and transportation » Administers a number of data collection, analysis and distribution programs on the regional trail system, including land acquisition, planning, implementation, monitoring and maintenance
Clean Water Services (CWS)	<ul style="list-style-type: none"> » Local environmental agency for water quality protection and enhancement » Provides regulatory guidance/standards for trail design and development located within vegetated corridors adjacent to creeks, stream and wetlands » Provides mitigation/enhancement requirements for impacts to vegetated corridors as a result of trail development

TABLE 3A TRAIL PLANNING PARTNERS (CONTINUED)

Trail Partner	Description
Washington County	<ul style="list-style-type: none"> » THPRD’s ultimate service area includes portions of urbanized, unincorporated Washington County, such as Aloha, Bethany, Bonny Slope, Cedar Hills and Cedar Mill » Local transportation planning agency, including bicycle and pedestrian systems (identified in the county’s transportation plan) » Provides regulatory guidance/standards for trail design and development when located in the public right of way and as part of the development review process » Provides funding and/or other assistance for trail design and development through county funding programs and/or capital improvement projects, such as bike lanes or widened sidewalks » Coordinates with THPRD and other local agencies to ensure compatibility between trails and transportation
City of Beaverton	<ul style="list-style-type: none"> » Located entirely within THPRD’s ultimate service area » Local transportation planning agency, including bicycle and pedestrian systems (identified in the city’s transportation plan) » Provides regulatory guidance/standards for trail design and development when located in the public right of way and as part of the development review process » Provides funding and/or other assistance for trail design and development through local funding programs and/or capital improvement projects, such as bike lanes or widened sidewalks » Coordinates with THPRD to ensure compatibility between trails and transportation
City of Hillsboro	<ul style="list-style-type: none"> » Located on the west side of THPRD’s ultimate service area » Local trails and transportation planning agency » Coordinates with THPRD to ensure compatibility with regional and community trail connections between service areas
City of Portland Parks & Recreation Bureau	<ul style="list-style-type: none"> » Located on the east side of THPRD’s ultimate service area » Local trails planning agency » Coordinates with THPRD to ensure compatibility with regional and community trail connections between service areas
City of Tigard	<ul style="list-style-type: none"> » Located on the south side of THPRD’s ultimate service area » Local trails and transportation planning agency » Coordinates with THPRD to ensure compatibility with regional and community trail connections between service areas

3.2 TRAIL SEGMENTS



The district’s trails system, illustrated in Figure 3C, includes nine regional trails and 16 community trails encompassing over 60 miles. Of the nine regional trails, six are previously identified in the 2006 Trails Master Plan and three are new, based on the development of this TFP. Eleven of the community trails come from the 2006 Trails Master Plan and five are new additions. Also illustrated on the 2015 Trail System Map are key neighborhood trails that provide connections from regional or community trails to significant points of interest, such as parks, natural areas, transit, schools or other areas of interest. Please note that while neighborhood trails are illustrated on the map, they are not designated by name in the same manner as regional and community trails are designated.

3.2.1 Current Trails

3.2.1.a Current Regional Trails

The district has six regional trails identified within its service area (based on the 2006 Trails Master Plan), traversing over 36 miles. Of these, two are nearly complete with only small segments remaining (Fanno Creek and Rock Creek Trails) and one is halfway complete (Westside Trail). The three remaining trails (Beaverton Creek, McKernan Creek (formerly named Cooper Mountain) and Tualatin Valley) have minimal, if any, segments completed. The following table illustrates the district’s regional trail network. These trails are illustrated in Figure 3C.

Trail segments that are constructed are considered “complete” in the status column in the following tables. Segments not constructed are deemed “incomplete” and segments that have portions constructed are considered “partial.” These status classifications apply to both regional and community trails. Please note, that although some trail segments are complete, they may be considered substandard. The following tables (3B – 3E) are intended to highlight trail system connectivity throughout the district. Please note that “Trail Status” marked with a “+” indicates a trail segment completed to a substandard condition to be enhanced in the future.

TABLE 3B CURRENT REGIONAL TRAIL DESCRIPTIONS

Segment	Description	Status	Length (miles)
R1: Rock Creek Trail			
1	Sunset Highway – Crescent Park Trail	Incomplete	0.69
2	Crescent Park Trail – 185th Avenue	Complete+	0.32
3	185th Avenue – West Union Road	Complete+	0.26
4	West Union Road – Waterhouse Trail	Complete+	1.00
5	Waterhouse Trail – Kaiser Road	Complete+	0.77
6	Kaiser Road – Westside Trail	Complete+	0.88
R3: Westside Trail			
1	Barrows Road – Scholls Ferry Road	Complete+	0.39
2	Scholls Ferry Road – Weir Road	Complete+	1.00
3	Weir Road – Galena Way	Complete+	0.26
4	Galena Way – Rigert Road	Complete+	0.64
5	Rigert Road – Hart Road	Complete+	0.38
6	Hart Road – Burntwood Way	Complete+	0.26
7	Burntwood Way – Davis Road	Complete+	0.39
8	Davis Road – Division Street	Complete+	0.42
9	Division Street – Farmington Road	Complete+	0.22
10	Farmington Road – TV Highway	Complete+	0.57
11	TV Highway – Merlo Light Rail Station	Partial+	0.76
12	Merlo Light Rail Station – Jenkins Road	Incomplete	0.29
13	Jenkins Road – Walker Road	Partial+	0.61
14	Walker Road – Sunset Highway	Incomplete	0.93
15	Sunset Highway – Cornell Road	Incomplete	0.31
16	Cornell Road – Oak Hills Drive	Incomplete	0.36
17	Oak Hills Drive – West Union Road	Partial+	0.43
18	West Union Road – Rock Creek Trail	Incomplete	1.81
19	Rock Creek Trail – THPRD Boundary	Incomplete	0.72

TABLE 3B **CURRENT REGIONAL TRAIL DESCRIPTIONS** (CONTINUED)

Segment	Description	Status	Length (miles)
R4: Beaverton Creek Trail			
1	THPRD Boundary – 185th Avenue	Incomplete	0.79
2	185th Avenue – 170th Avenue	Incomplete	0.91
3	170th Avenue – Murray Boulevard	Partial+	1.56
4	Murray Boulevard – Cedar Hills Boulevard	Incomplete	1.13
5	Cedar Hills Boulevard – Lombard Avenue	Incomplete	0.52
6	Lombard Avenue – Allen Boulevard	Partial+	1.21
7	Allen Boulevard – Denney Road	Partial+	0.51
8	Denney Road – Fanno Creek Trail	Partial+	0.49
R5: Tualatin Valley Trail			
1	Reedville Trail – 185th Avenue	Incomplete	0.53
2	185th Avenue – Westside Trail	Incomplete	1.38
3	Westside Trail – Murray Boulevard	Incomplete	0.63
4	Murray Boulevard – Erickson Street	Incomplete	1.42
5	Erickson Street – Beaverton Creek Trail	Incomplete	1.04
R7: Fanno Creek Trail			
1	Scholls Ferry Road – Hall Boulevard	Complete+	1.17
2	Hall Boulevard – Denney Road	Complete+	0.70
3	Denney Road – BSD Maintenance Shop	Partial+	0.74
4	BSD Maintenance Shop – Scholls Ferry Road	Complete+	0.68
5	Scholls Ferry Road – 92nd Avenue	Incomplete	0.11
6	92nd Avenue – Oleson Road	Complete+	1.15
R7: McKernan Creek Trail (formerly the Cooper Mountain Trail)			
1	South Cooper Loop Trail – 175th Avenue	Incomplete	2.14
2	175th Avenue – Summercrest Park	Incomplete	0.79
3	Summercrest Park – Westside Trail	Complete+	0.47

3.2.1.b Current Community Trails

The district has 11 community trails identified within its service area (based on the 2006 Trails Master Plan), traversing over 30 miles. Of these trails, only the Waterhouse Trail has been nearly completed (only a fifth mile gap remains unconstructed of the 5 mile trail). The remainder of the district’s community trails has only partially completed segments or has not yet been constructed. The following table outlines the district’s community trail network. These trails are illustrated in Figure 3C. Please note that “Trail Status” marked with a “+” indicates a trail segment completed to a substandard condition to be enhanced in the future.

TABLE 3C CURRENT COMMUNITY TRAIL DESCRIPTIONS

Segment	Description	Status	Length (miles)
C1.1: North Bethany Trail			
1	Rock Creek Trail – Reindeer Drive	Complete+	0.13
2	Reindeer Drive – Springville Road	Incomplete	0.26
3	PCC Rock Creek Recreation Facility	Complete	0.85
4	PCC Rock Creek Recreation Facility – Bethany Creek Trail #1	Incomplete	1.46
C1.2: Bethany Creek Trail #1			
1	North Bethany Trail – Kaiser Road	Incomplete	0.46
2	Kaiser Road – Bethany Creek Trail #2	Incomplete	0.76
C1.3: Bethany Creek Trail #2			
1	Waterhouse Trail – Kaiser Road	Incomplete	0.64
2	Kaiser Road – Springville Road	Incomplete	0.76
3	Springville Road – Westside Trail	Incomplete	0.44
C1.4: Bethany Creek Trail #3			
1	Waterhouse Trail – Kaiser Road	Incomplete	0.46
2	Kaiser Road – North Bethany Trail	Incomplete	0.51

TABLE 3C **CURRENT COMMUNITY TRAIL DESCRIPTIONS** (CONTINUED)

Segment	Description	Status	Length (miles)
C1.4: Bethany Creek Trail #3			
1	Waterhouse Trail – Kaiser Road	Incomplete	0.46
2	Kaiser Road – North Bethany Trail	Incomplete	0.51
C2: Bronson Creek Trail			
1	Cornell Road – Sunset Highway	Complete+	0.18
2	Sunset Highway – 174th Avenue	Incomplete	0.09
3	174th Avenue – West Union Road	Incomplete	0.99
4	West Union Road – Westside Trail	Incomplete	0.60
5	Westside Trail – Laidlaw Road	Incomplete	1.05
6	Laidlaw Road – Westside Trail	Partial+	0.63
C4: Cedar Mill Creek Trail			
1	Lost Springs Drive – Bonny Slope West Trail	Complete+	0.57
2	Bonny Slope West Trail – Foege Park/Cedar Hills Boulevard	Complete+	0.47
3	Foege Park/Cedar Hills Boulevard – North Johnson Creek Trail	Partial+	0.61
4	North Johnson Creek Trail – Barnes Road	Partial+	0.30
5	Barnes Road – Lost Springs Drive	Complete+	0.30
C5: Willow Creek Trail			
1	Willow Drive – MAX Line	Incomplete	0.34
2	MAX Line – Heritage Parkway	Incomplete	0.45
3	Heritage Parkway – Walker Road	Incomplete	0.47
4	Walker Road – 173rd Avenue	Incomplete	0.33
5	173rd Avenue – Waterhouse Avenue	Complete+	0.62
C5: Willow Creek Trail			
6	Waterhouse Avenue – 153rd Avenue	Incomplete	0.47

TABLE 3C CURRENT COMMUNITY TRAIL DESCRIPTIONS (CONTINUED)

Segment	Description	Status	Length (miles)
C6: Waterhouse Trail			
1	Merlo Road – Baseline Road	Complete	0.59
2	Baseline Road – Walker Road	Complete+	0.49
3	Walker Road – Willow Creek Greenway	Complete+	0.71
4	Willow Creek Greenway – Sunset Highway	Partial+	0.18
5	Sunset Highway – Jocelyn Street	Complete	0.82
6	Jocelyn Street – Stoller Creek Greenway	Complete+	0.89
7	Stoller Creek Greenway – Waterhouse Linear Park	Complete+	0.16
8	Waterhouse Linear Park – Springville Road	Complete+	0.66
9	Springville Road – THPRD Boundary	Incomplete	0.87
C7: North Johnson Creek Trail			
1	Cedar Mill Creek Trail – Valeria View Drive	Incomplete	0.83
2	Valeria View Drive – Sunset Transit Center	Incomplete	0.36
3	North Johnson Creek Trail – Miller Road	Incomplete	1.51
4	Miller Road – Cornell Road	Incomplete	0.97
C8 – Beaverton Wetlands Trail			
1	TV Trail – Westside Trail	Complete+	0.66
C9 – South Johnson Creek Trail			
1	TV Highway – Farmington Road	Incomplete	0.48
2	Farmington Road – Division Street	Incomplete	0.36
3	Division Street – Village Lane	Incomplete	0.31
4	Village Lane – Davis Road	Incomplete	0.24
5	Davis Road – Hart Road	Partial+	0.85
6	Hart Road – Sexton Mountain Drive	Partial+	0.55
7	Sexton Mountain Drive – Beard Road	Incomplete	0.54
8	Beard Road – Murray Boulevard	Incomplete	0.73
9	Murray Boulevard – Scholls Ferry Road	Incomplete	0.59

3.2.2 New Trails



As the district’s service area continues to urbanize within its outer fringe, new trails will be needed to serve residents and further expand the district’s existing and planned trail system. This includes the areas of Aloha-Reedville in the west, Bonny Slope West in the northeast and South Cooper Mountain in the southwest. The trails identified in the tables below are a result of planning efforts undertaken by Washington County (Aloha-Reedville, Bonny Slope West) and Beaverton (South Cooper Mountain). Although already urbanized and developed, the area east of Highway 217 is also in need of trails that would connect residents north towards US26 and west towards the Beaverton Creek and Tualatin Valley Trails.

3.2.2.a New Regional Trails

The following table highlights three new regional trails the district needs to plan for as the areas described above begin to urbanize and develop. This includes the north-south Reedville Trail, which will connect the South Cooper Loop Trail to the Tualatin Valley and Beaverton Creek trails; and the South Cooper Loop Trail, which runs east-west connecting the Westside Trail to the Reedville Trail in the district’s southwest quadrant. The Crescent Park Trail also runs east-west and will connect to the Rock Creek Trail from the City of Hillsboro (based on Hillsboro’s updated 2015 trails master plan) in the district’s northwest quadrant. These trails are illustrated in Figure 3C.

TABLE 3D NEW REGIONAL TRAILS

Segment	Description	Status	Length (miles)
R2: Crescent Park Trail			
1	THPRD Boundary – Rock Creek West Soccer Fields	Incomplete	0.28
2	Rock Creek West Soccer Fields – Rock Creek Trail	Complete	1.32
R6: Reedville Trail			
1	THPRD Boundary – South Cooper Loop Trail	Incomplete	0.93
2	South Cooper Loop Trail – THPRD Boundary	Incomplete	0.57
6	Jocelyn Street – Stoller Creek Greenway	Complete+	0.89
7	Stoller Creek Greenway – Waterhouse Linear Park	Complete+	0.16
8	Waterhouse Linear Park – Springville Road	Complete+	0.66
9	Springville Road – THPRD Boundary	Incomplete	0.87
R9: South Cooper Loop Trail			
1	Reedville Trail – Farmington Road	Incomplete	0.36
2	Farmington Road – Grabhorn Road	Incomplete	1.44
3	Grabhorn Road – McKernan Creek Trail	Incomplete	0.74
4	McKernan Creek Trail – Scholls Ferry Road	Incomplete	1.01
5	Scholls Ferry Road – Roy Rogers Road	Incomplete	0.90
6	Roy Rogers Road – Barrows Road	Incomplete	0.42
7	Barrows Road – Barrows Park	Incomplete	0.51
8	Barrows Park – Westside Trail	Complete	0.49

TABLE 3E **NEW COMMUNITY TRAILS**

Segment	Description	Status	Length (miles)
C3: Bonny Slope West Trail			
1	Cedar Mill Creek Trail – Thompson Road	Incomplete	1.63
2	Thompson Road – Bronson Creek Trail	Incomplete	1.36
C10.1: South Cooper Mountain Trail #1			
1	McKernan Creek Trail – South Cooper Loop Trail	Incomplete	1.35
C10.2 – South Cooper Mountain Trail #2			
1	McKernan Creek Trail – South Cooper Loop Trail	Incomplete	1.14
C10.3 – South Cooper Mountain Trail #3			
1	South Cooper Loop Trail – South Cooper Mountain Trail #9.1	Incomplete	1.11
C11 – North Cooper Mountain Trail			
1	South Cooper Loop Trail – 190th Avenue	Incomplete	0.93
2	190th Avenue – Cooper Mountain Nature Area	Incomplete	0.38
3	Cooper Mountain Nature Area – McKernan Creek Trail	Incomplete	0.81

3.2.2.b New Community Trails

The following table highlights the five new community trails the district needs to plan for as the areas described above begin to urbanize and develop. This includes the Bonny Slope Area in the northeast and the Cooper Mountain area in the southwest. These trails are illustrated in Figure 3C.

3.2.3 Trail Corridor Study Areas

It should be noted that much of the district's remaining (to be constructed) regional and community trail systems are located within creek corridors and other environmentally sensitive areas. These trail corridors have been identified on the 2016 Trail System Map (Figure 3C) as study areas, which mean these areas do not have a defined trail alignment at this time.

These study areas will undergo a feasibility analysis incorporating both this TFP's Trail Prioritization Criteria Matrix (Table 5A) and the district's Natural Resource Functional Plan's (NRFP) Site Development Suitability Criteria (Table 5A in the NRFP) to determine an appropriate trail alignment. Although this analysis could result in the recommendation that a trail, or portion of a trail, be located outside of the resource area (possibly as an on-street connection), require additional natural area mitigation along the trail corridor or not be constructed at all, it is the desire of the district to provide off-street trails and connectivity whenever reasonable. Where

the TFP trail prioritization criteria indicates a high priority for trail development and the NRFP site suitability criteria indicates a high priority for natural resource function, it shall be up to the district's management team and/or board of directors to determine which priority takes precedence.

For those trail corridors located within creek corridors or other environmentally sensitive areas but not identified on the trail system map in a study area, this same feasibility analysis will take place in order to determine the most appropriate trail alignment.

3.2.4 Maps

3.2.4.a 2006 Trail System

Figure 3A illustrates the district's trail system at the time of the 2006 Trails Master Plan. This map provides a historical look at the trail system prior to the passage of the 2008 bond measure and the completion of a number of trail segments throughout the district.

3.2.4.b Trailshed Analysis

Figure 3B illustrates walkable access for district residents to district facilities from constructed district trails. This analysis was completed as part of the 2013 Comprehensive Plan Update, which calls for an emphasis on walkable access to district facilities such as trails, parks, natural areas and recreation/aquatic centers. This map also illustrates walkable access to the district's trail system; represented by the shaded areas (each color represents one trailshed). This map is for reference only (more detailed information can be found in the 2013 Comprehensive Plan Update).

3.2.4.c 2015 Trail System

Figure 3C illustrates the existing and planned trail system in THPRD's service area. It also shows the context of existing and planned trails of other jurisdictions. It should be noted that some of the future trails are depicted as study areas, indicating these trail corridors are located in natural areas and require an additional level of analysis with site suitability criteria identified in the district's NRFP to ensure trail and resource area compatibility. A large scale map can be found in the appendix for better legibility.

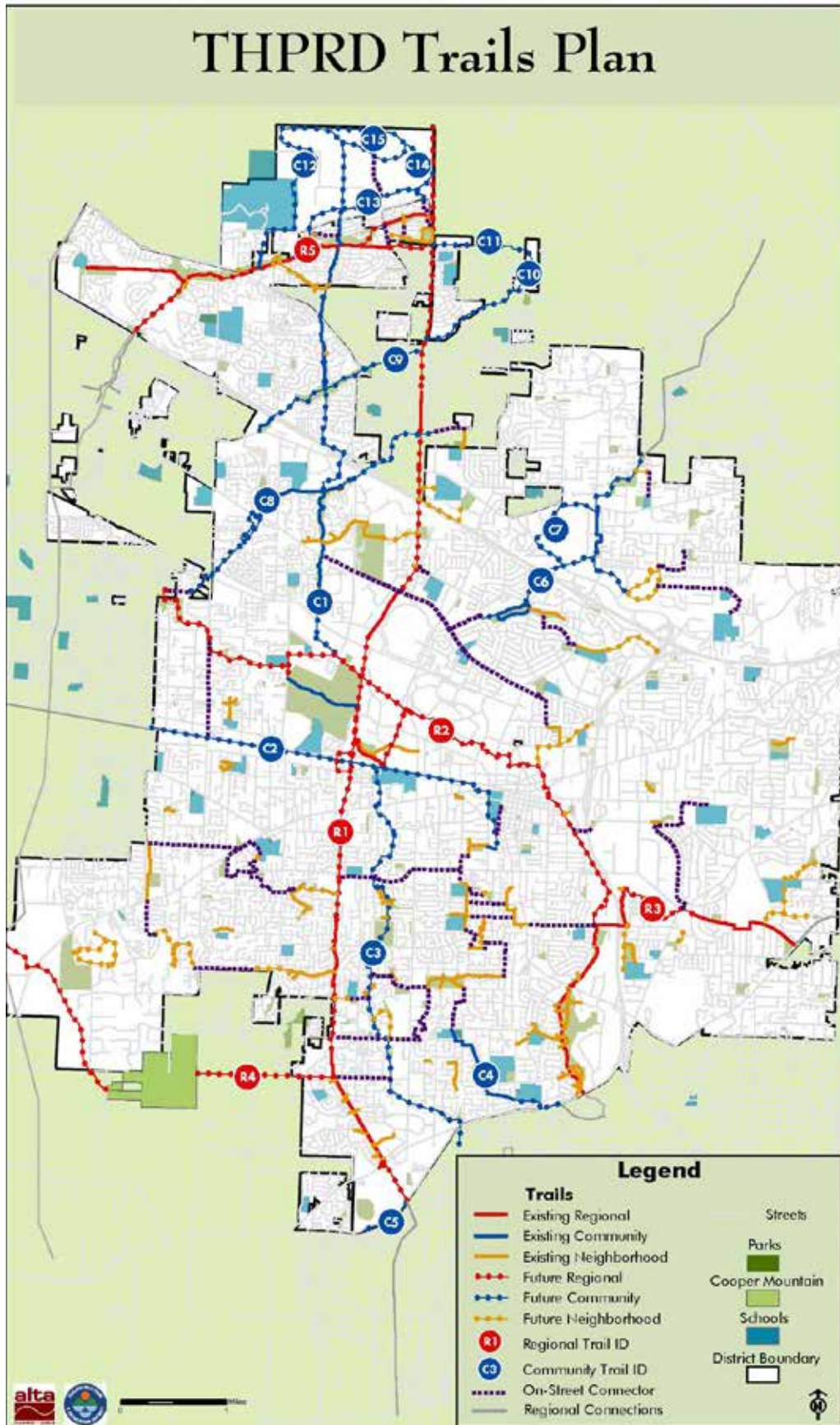

FIGURE 3A 2006 TRAIL SYSTEM

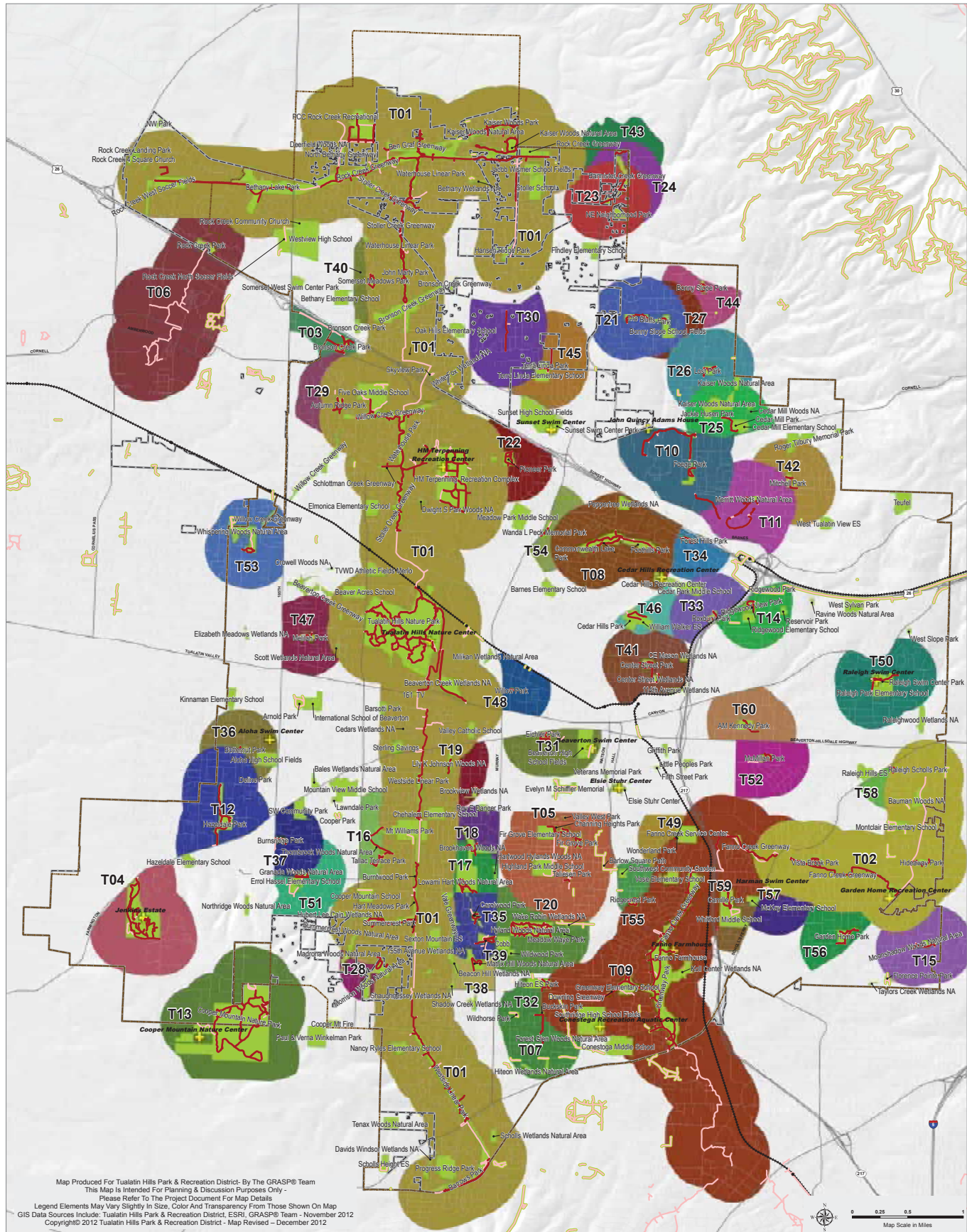

FIGURE 3B TRAILSHED ANALYSIS

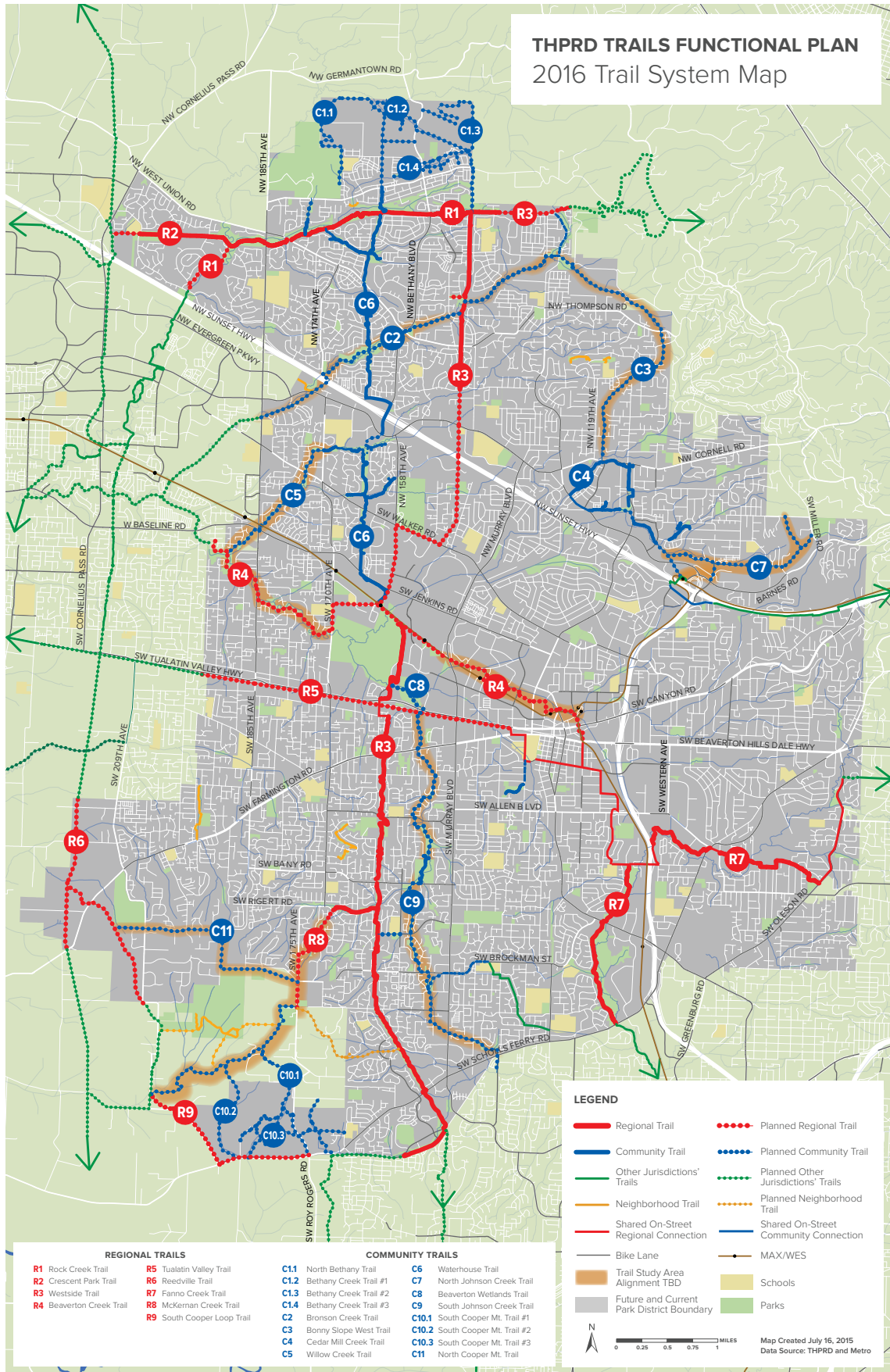

FIGURE 3C 2016 TRAIL SYSTEM



ACHIEVING SUCCESS

To facilitate the district's desire to provide, maintain and operate a quality trail system, a number of guidelines have been established. A number of elements need to be considered, including, but not limited to, trail classifications, accessibility, amenities, surfacing, bridges and boardwalks and mid-block crossings. This section of the TFP provides the guidance necessary to ensure district trails meet user expectations.

4.1 TRAIL DESIGN STANDARDS BY CLASSIFICATION

A complete trail network provides a variety of experiences within a range of settings. THPRD’s system includes routes that provide recreational opportunities as well as alignments that present viable transportation alternatives for bicycle commuters. The system includes three main functional classes of trails:

- » Regional Trail
- » Community Trail
- » Neighborhood Trail

See Section 3.1.2 above for definitions of the trail classifications. Table 4A below provides guidance on trail design based on classification and Figures 4A through 4C illustrate a typical trail cross-section for each trail classification.

FIGURE 4A
Regional trail typical section

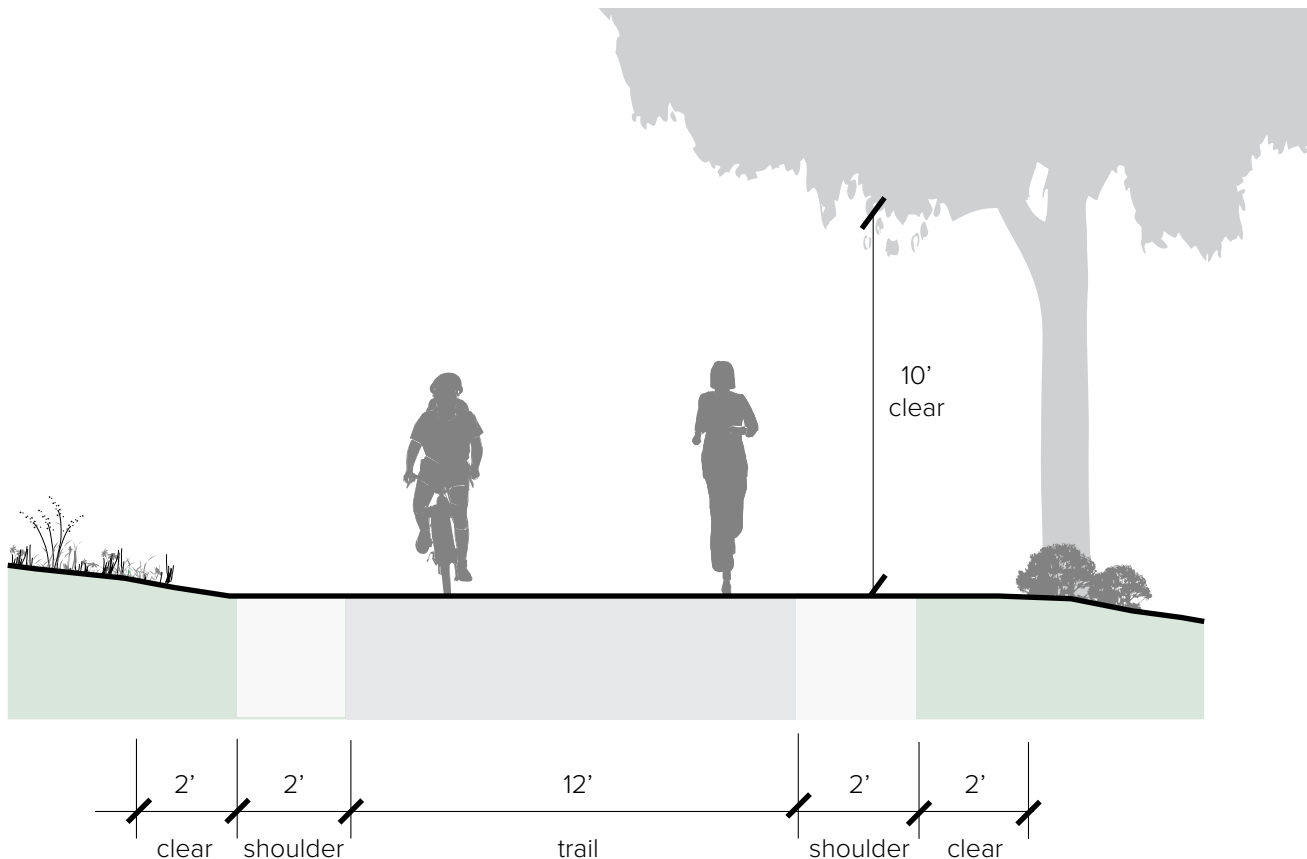

FIGURE 4B
Community trail typical section

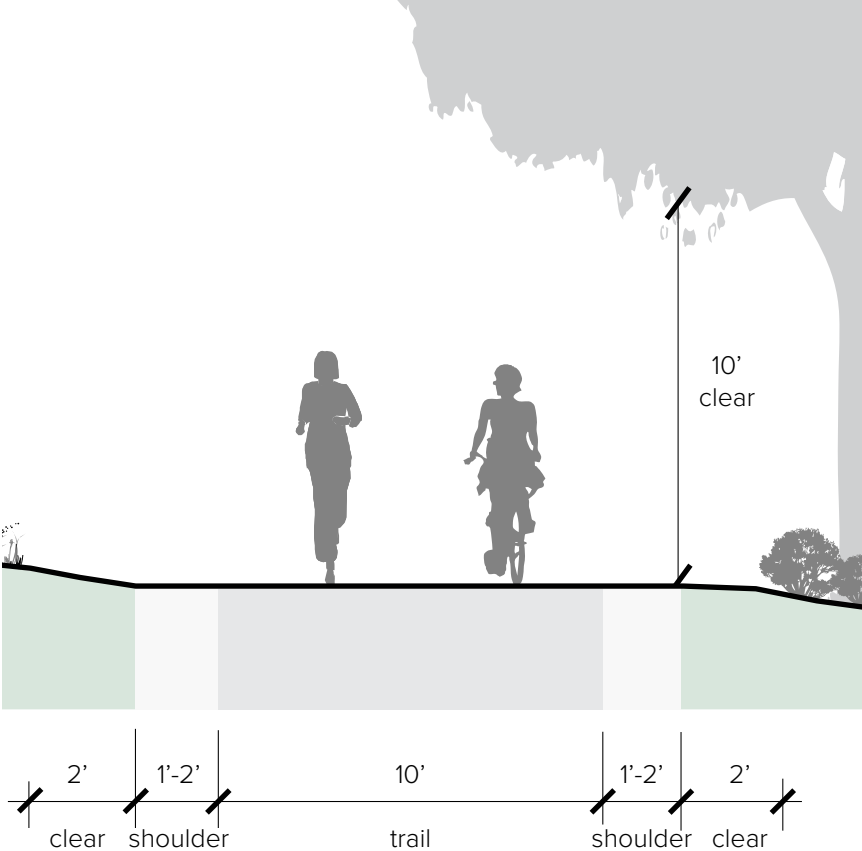

FIGURE 4C
Neighborhood trail typical section

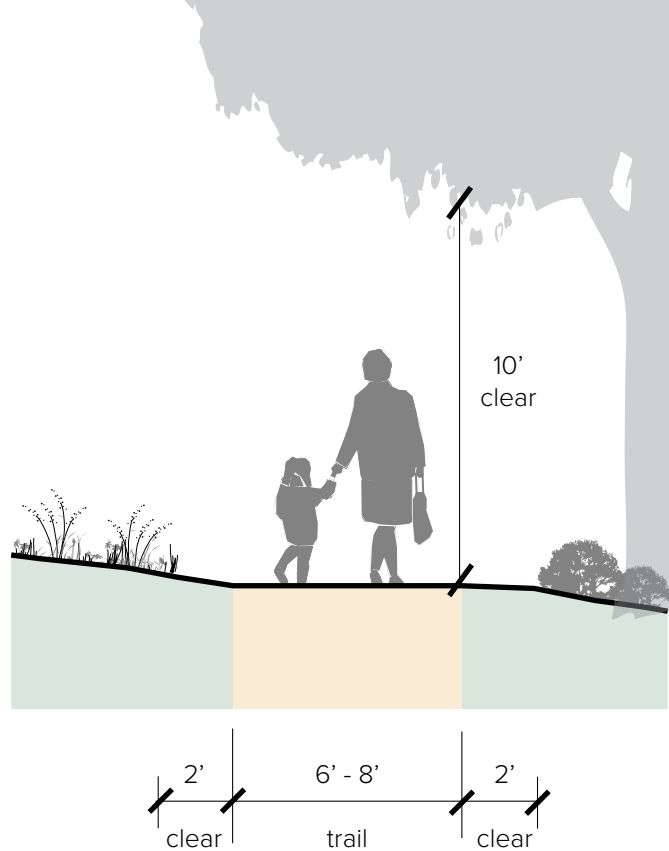

TABLE 4A TRAIL CLASSIFICATION DESIGN MATRIX

Classification	Function	Materials	Width	Vertical Clearance*	Horizontal Clearance**
Regional	Provides transportation and recreational connectivity at a regional scale	Paved (asphalt or concrete); may be pervious	12 feet with 2 foot gravel shoulder	10 feet (from top of trail)	2 feet (from edge of shoulder)
Community	Provides recreational and transportation connectivity at a community scale	Paved (asphalt or concrete; may be pervious)	10 feet with 1-2 foot gravel shoulder	10 feet (from top of trail)	2 feet (from edge of shoulder)
Neighborhood (Urban)	Provides access or a parallel route to higher level trail facilities	Paved	6-8 feet, with or without gravel shoulder	10 feet (from top of trail)	2 feet (from edge of shoulder or trail w/o shoulder)
Neighborhood (Natural)	Linear natural spaces typically following riparian corridors	Varies depending on site conditions	6-8 feet, no gravel shoulder	10 feet (from top of trail)	2 feet (from edge of trail)

*Area above the trail free from obstructions such as tree limbs or branches

**Area on both sides of trail free from obstructions such as shrubs and trees

TABLE 4B ADDITIONAL TRAIL TYPE DESIGN MATRIX

Classification	Function	Materials	Width	Vertical Clearance*	Horizontal Clearance**
Combined Trail and Sidewalk	Provides route options for both bicyclists and pedestrians outside of existing roadway corridors	Paved (asphalt or concrete)	12 feet (sidewalk and trail)	10 feet (from top of trail)	2 feet (from edge of trail)
Trail Adjacent to a Road or Sidewalk	Separated route within a transportation corridor	Paved	Regional Trail: 12 feet; Community: 10 feet	Vertical curb between trail and roadway; 10 feet (from top of trail)	4 feet landscape buffer between trail and roadway/sidewalk; 4 feet (from edge of trail) - non-landscape buffer side)
Trail in a Greenway	Provides route for both pedestrians and bicyclists using riparian corridors and/or wetland areas	Paved or unpaved	6-8 feet; should include a vegetated buffer zone from adjacent water bodies	10 feet (from top of trail)	2 feet (from edge of trail)

*Area above the trail free from obstructions such as tree limbs or branches
 **Area on both sides of trail free from obstructions such as shrubs and trees

4.2 ADDITIONAL TRAIL TYPE DESIGN STANDARDS

Trails of each classification traverse many types of environments and contexts. The standards in Table 4B provide guidance for some common trail types, based on site context.

Any new or improved sidewalks should adhere to the requirements of the City of Beaverton or Washington County, as appropriate. The district should partner with both agencies as road improvements are being planned along trail corridors to help ensure bicycle and pedestrian needs are adequately met.

FIGURE 4D
Combined trail and sidewalk typical section

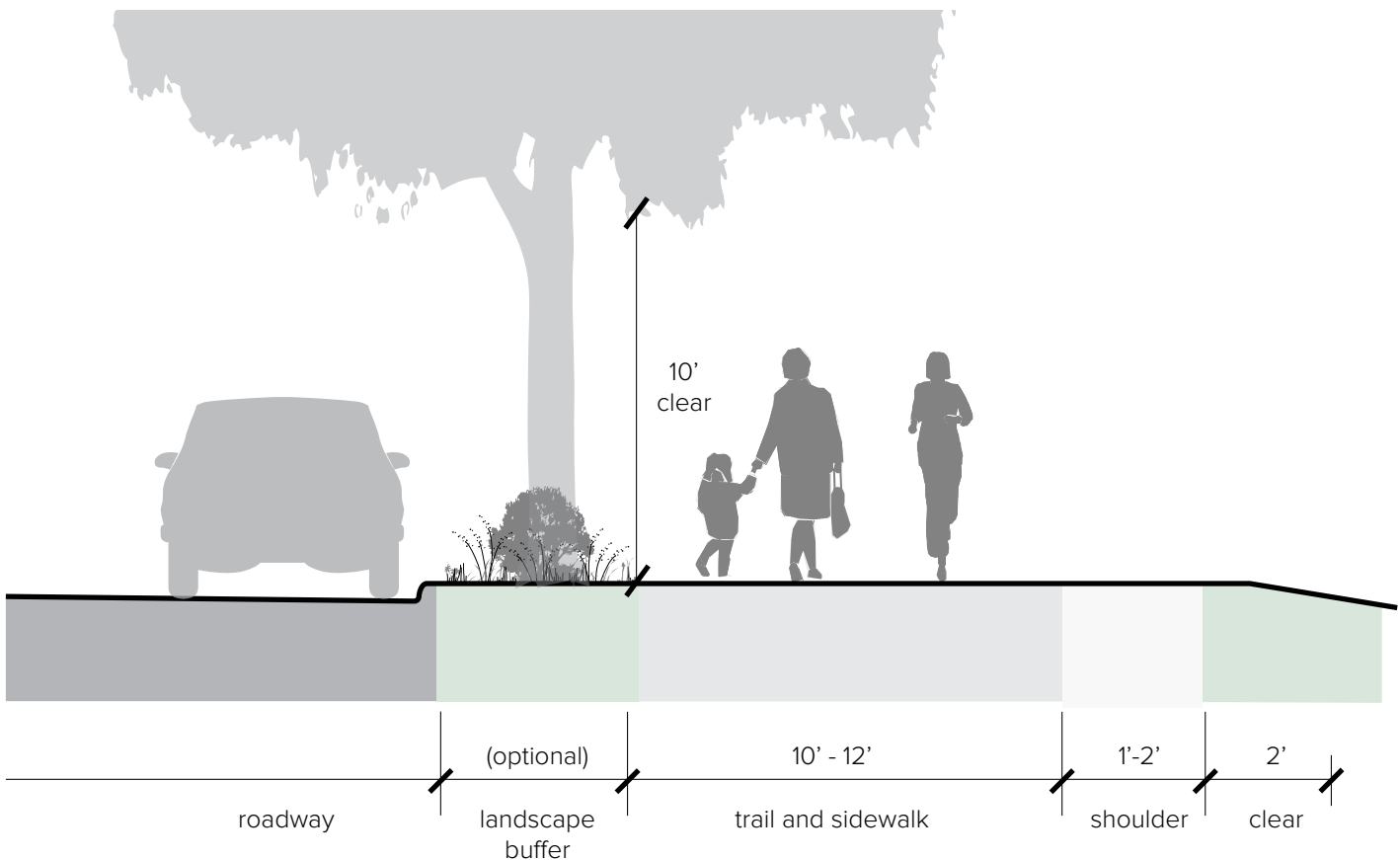

4.2.1 Combined Trail and Sidewalk

Shared use paths are completely separated from motorized vehicular traffic and are constructed in the public right of way, within a green space area, public utility corridor or other public access area. Combined sidewalks and trails are generally located adjacent to roadways within the public right of way. They may be separated from the curb by a landscape buffer or they may be “curb-tight,” connected to the curb.

Trail design standards for these types of facilities are described in the table above. Additional consideration should also be given to enhancing the user experience and safety for both bicycles and pedestrians, including the use of striping, landscaping, clear sight lines and other design considerations described later in this section. Figures 4D and 4E illustrate typical cross-sections for these two trail types.

FIGURE 4E
Trail adjacent to a roadway, trail typical section

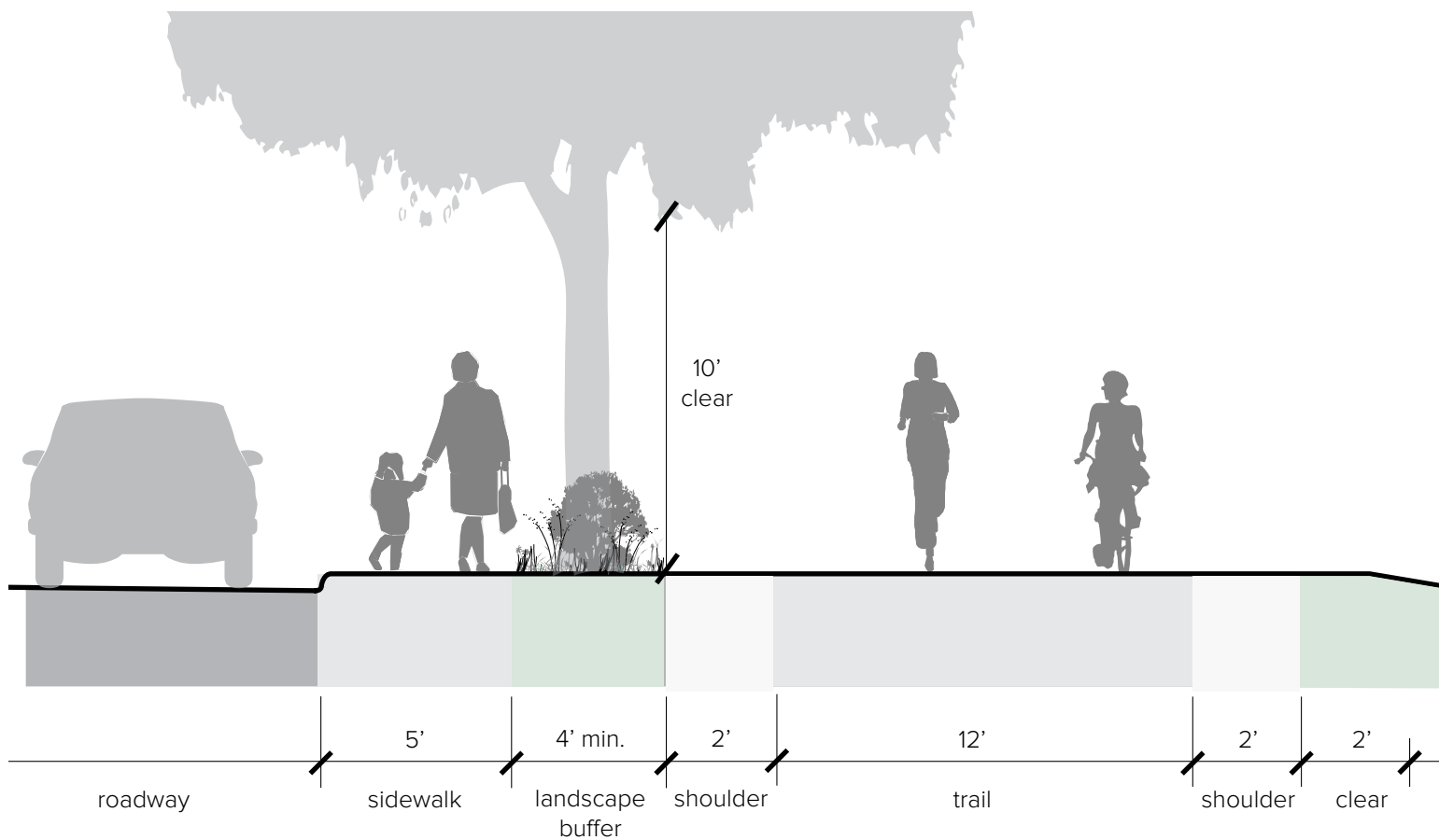

4.2.2 Trails within Greenways



Due to much of the district's service area being urbanized, limited opportunities are available to develop new off-street trails. Much of the district's remaining (to be constructed) regional and community trail system is located within environmentally sensitive areas, such as creek corridors and greenways. Greenways are defined as follows:

Greenways are linear natural spaces that follow creeks and streams. Some greenways provide public access with environmentally compatible trails, viewpoints, or watercraft launch sites. Other greenways prioritize wildlife habitat protection and do not allow any public access. (Metro, Regional Trails and Greenways Plan)



Greenways offer substantial recreational and green space preservation opportunities. When planning for a trail along or in a greenway, a balance must be provided between the protection of natural resources and the public's desire for access to natural resource areas. Trails within greenways should be studied to identify impacts to natural resource areas, stormwater, flora and fauna, and flood levels as well as recreational and transportation benefits for district residents.

As mentioned previously in this TFP, the trail system map (Figure 3C) highlights study areas where trails are planned to be located along or within creek corridors. This includes trails such as Beaverton Creek, Bronson Creek, Willow Creek and others. Section 3.2.3 outlines the process of how these study areas will be evaluated using both trail prioritization criteria outlined in this plan and the site development suitability criteria outlined in the district's NRFP.

The following principles provide some general environmental considerations for trail development within greenways:

» Consider

- Alignments to minimize the number of stream crossings
- Circulation and/or migration of local fauna
- Impact of on-site vs. off-site mitigation
- Opportunities for the restoration of poor water quality, habitat areas and/or stream edges
- Interpretive or educational elements to highlight local features, flora and fauna
- Use of concrete as a surface treatment option for trails in greenway due to its durability and lower maintenance requirements
- Natural dispersed infiltration systems such as vegetated swales or infiltration strips to manage stormwater
- Construction materials with little to no toxicity (see <http://www.pharosproject.net>)

» Avoid

- Fragmentation of small habitats
 - Wetlands whenever possible, but if necessary span at the narrowest point
 - Constructing trails that may be more prone to erosion and maintenance upkeep over time
 - Use of pervious paving in floodplain areas or areas without proper drainage due to sedimentation and higher maintenance requirements
- » Maintain buffer zones (vegetated corridors) from creeks, streams and sensitive bodies of water per Clean Water Services standards



4.3 DESIGN EXCEPTIONS

The design standards and guidelines outlined in this section are the district’s best practices and basis for design of all planned trails. However, trail development requires consideration of the local context, project site conditions, the environment and jurisdictional requirements.

During the master planning and design development process, the district will consider alternatives to the standard width dimensions, turning radii, surface treatments and other elements when justification is provided to address the following factors:

- » User safety
- » Avoidance of and/or minimizing environmental impact
- » Consideration of topography
- » Demand and anticipated level of use
- » Cost
- » Regional or local jurisdictional guidance, such as Metro’s Active Transportation Plan

Generally, trail widths less than the standard are only to be used over short distances, such as around utility poles, bridge abutments, significant trees or in sensitive natural resource areas. Trail widths greater than the standard width may also be considered in high use areas, such as near commercial centers, transit, schools and recreation facilities. Design exceptions may require approval by the district’s management team.



4.4 ACCESSIBILITY

4.4.1 ADA

The Americans with Disabilities Act (ADA) was established to prohibit discrimination on the basis of disability by public accommodations and requires places of public accommodation and commercial facilities to be designed, constructed and altered in compliance with the accessibility standards established by the ADA. As new trails are developed and existing trails are enhanced, the district will work on meeting ADA requirements to ensure access for all.

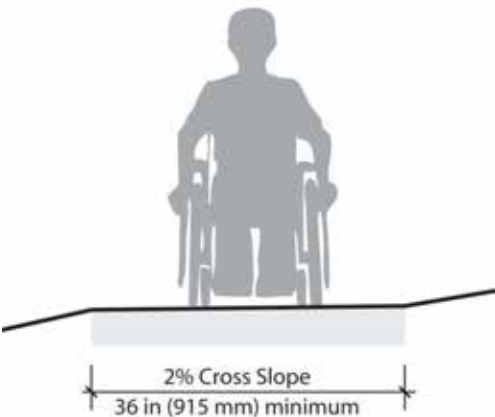

4.4.2 ADAAG

The United States Access Board has approved the Americans with Disabilities Act Accessibility Guidelines (ADAAG) for trails and outdoor recreational access routes. However, some trails may have limitations that make meeting ADAAG guidelines difficult or prohibitive. Prohibitive impacts include harm to significant cultural or natural resources, requirements of construction methods that are against federal, state or local regulations, or terrain characteristics that prevent compliance.

Some key ADAAG guidance considerations include:

- » Use of firm and stable surfaces, such as asphalt, concrete, wood, recycled plastic lumber or compacted gravel, wherever universal accessibility is a consideration
- » Provide clear tread width a minimum of 3 feet
- » Provide a 5 foot wide passing space at a minimum of every 1,000 feet when the trail width is less than 5 feet wide
- » Avoid surface obstacles more than one-half inch high, or 2 inches high when the surface is other than asphalt, concrete wood or recycled plastic lumber
- » Avoid a cross slope more than 2%, or 5% where the surface is not asphalt, concrete, wood or recycled plastic lumber when necessary for drainage
- » Longitudinal slope must meet one or more of the following conditions shown in Table 4C
- » Provide detectable surface changes at curb ramp approaches from roadways or parking areas
- » Provide one accessible parking space per every 25 vehicle spaces at trailheads
- » No more than 30% of the total trail length may exceed a running slope of 8.33%

TABLE 4C MAXIMUM RUNNING SLOPE AND LENGTH

Running slope		Maximum Length of Segment
Steeper than	But no more steep than	
1 : 0 (0%)	1 : 20 (5%)	No Limit
1 : 20 (5%)	1 : 12 (8.33%)	200 feet
1 : 12 (8.33%)	1 : 10 (10%)	30 feet
1 : 10 (10%)	1 : 8 (12%)	10 feet

ADA Accessibility Guidelines (ADAAG), ADA Standards, <https://www.access-board.gov/guidelines-and-standards/buildings-and-sites/about-the-ada-standards/background/adaag>

4.5 REGULATORY

4.5.1 Oregon Department of Transportation (ODOT)



ODOT has adopted the American Association of State Highway and Transportation Officials (AASHTO) Guide for the Development of Bicycle Facilities for trail design standards. The AASHTO guide should be consulted for geometric design standards such as horizontal and vertical curves, and sight-distance. This is especially important for those trails serving a transportation function, such as regional trails. Any trail projects receiving federal funding assistance will be required to meet ODOT standards in its design and development.

4.5.2 American Association of State Highway and Transportation Officials (AASHTO)

The AASHTO Guide for the Development of Bicycle Facilities generally recommends against the development of trails along roadways. These facilities create a situation where a portion of the bicycle traffic rides against the normal flow of motor vehicle traffic and can result in wrong-way riding when either entering or exiting the trail. As mentioned above, AASHTO provides guidance for the geometric design of trail design and construction. These standards should be considered for all trail projects and are required to be met for all federally funded trail projects.

4.5.3 Manual of Uniform Traffic Control Devices (MUTCD)

The MUTCD regulates the design and use of all traffic control devices including signs and pavement markings. A summary of the MUTCD guidance for trails and bicycles includes the following:

- » Use of a solid yellow line when passing is discouraged
- » Use of a dashed yellow line when passing is permitted due to adequate conditions
- » Use of striping in areas of restricted sight-distance, substandard trail width, high traffic areas, intersection approaches and/or where night time riding is expected with limited lighting
- » Avoid over-striping trails in order to maintain effectiveness for trail user safety purposes
- » Any transportation related signage (regulatory, caution, directional, etc.) visible from roadways or other public right of way must meet MUTCD standards

Please note that the district's Trails Management Program contains more detailed information related to MUTCD guidance and how the district puts this guidance into practice along the trails system.

4.5.4 Utilities

Many types of utilities, such as water, gas, electric and others offer good opportunities for trail co-location. Recreational and utility co-use has some complications, including the unique needs of the utility company or public agency. However, with strategic maintenance and land agreements, utilities can have a minimal effect on trail users. Additionally, utility companies usually benefit by having an uninterrupted and easily accessible route to their utility service.

Each utility has specific requirements regarding trail routing, alignment, setbacks, loading, landscaping and other factors. For each project all utilities should be coordinated with to ensure current requirements are being used as well as to better understand utility maintenance schedules and servicing needs, including frequency and vehicle/equipment requirements. Limitations may be placed on trail surfacing materials and location of structures, such as bridges and boardwalks, depending on utility type and location.

The district works with the following utility providers on many of its trail projects:

- » Bonneville Power Administration (BPA)
- » Portland General Electric Company (PGE)
- » Northwest Natural Gas (NWN)
- » Tualatin Valley Water District (TVWD)
- » Clean Water Services (CWS)
- » City of Beaverton
- » City of Portland

4.5.5 Railroad / TriMet

As with utilities, some of the district's trails are, or will be, located in right of way owned by Union Pacific Railroad and operated by Portland & Western Railroad or owned and operated by TriMet. As such, coordination with each of these agencies is needed to ensure their respective requirements are being met. Because most of these are live railroad right of ways, additional safe guards must be considered when design and constructing trails. This includes consideration of the following:

- » Use of fencing and/or other separation techniques should be part of the trail design when adjacent to railroad tracks
- » Maximize the setback between the trail and the railroad tracks to the greatest extent possible; subject to railroad, federal, state and regional guidelines

4.6 SURFACING

When determining surface type for THPRD trails, consider topography, landscape context, underlying soils, trail type and classification. Asphalt is the preferred standard for all regional and community trail surfacing, but alternative trail surfacing may be allowed with a design exception. All surfaces have advantages and disadvantages, and each must be analyzed to determine which surface is most appropriate in any given location.

4.6.1 Impervious

Traditionally, asphalt and concrete are the most commonly used materials for trails because they last the longest, meet ADA and ADAAG requirements and meet the needs of most users. Other possible trail surfacing options include:

- » Commercial soil stabilizers
- » Geotextile confinement systems
- » Crusher fines
- » Limestone treated surfaces
- » Recycled plastic or wood decking

Surfacing options for bridges and boardwalks are identified in Section 4.8.3.

In arriving at a recommended trail surface, the following should be considered:

- » Initial capital cost and funding
- » Long-term maintenance costs
- » Surfacing durability and longevity
- » Existing soil and environmental conditions
- » Availability of materials
- » Anticipated trail use/functionality
- » Aesthetics

ADA and ADAAG-compliant trails require paved surfaces, in most instances, for access and ease of use. In limited cases, packed gravel fines can be used, where there is little to no topography. However, packed surfaces require much more maintenance effort and cost over time, and may not be desirable in the long term.

Asphalt

Asphalt trails offer substantial durability for the cost of installation and maintenance. Asphalt is popular with users for its smooth, continuous surface and has the benefit of lower cost, but requires more upkeep in comparison to concrete. As a flexible pavement, asphalt can also be considered for installing as a paved trail in a greenway or with grades steeper than three percent. If constructed properly on suitable sub-grade, asphalt has a life span of ten to 15 years. The use of asphalt for trails is the district’s preferred standard.

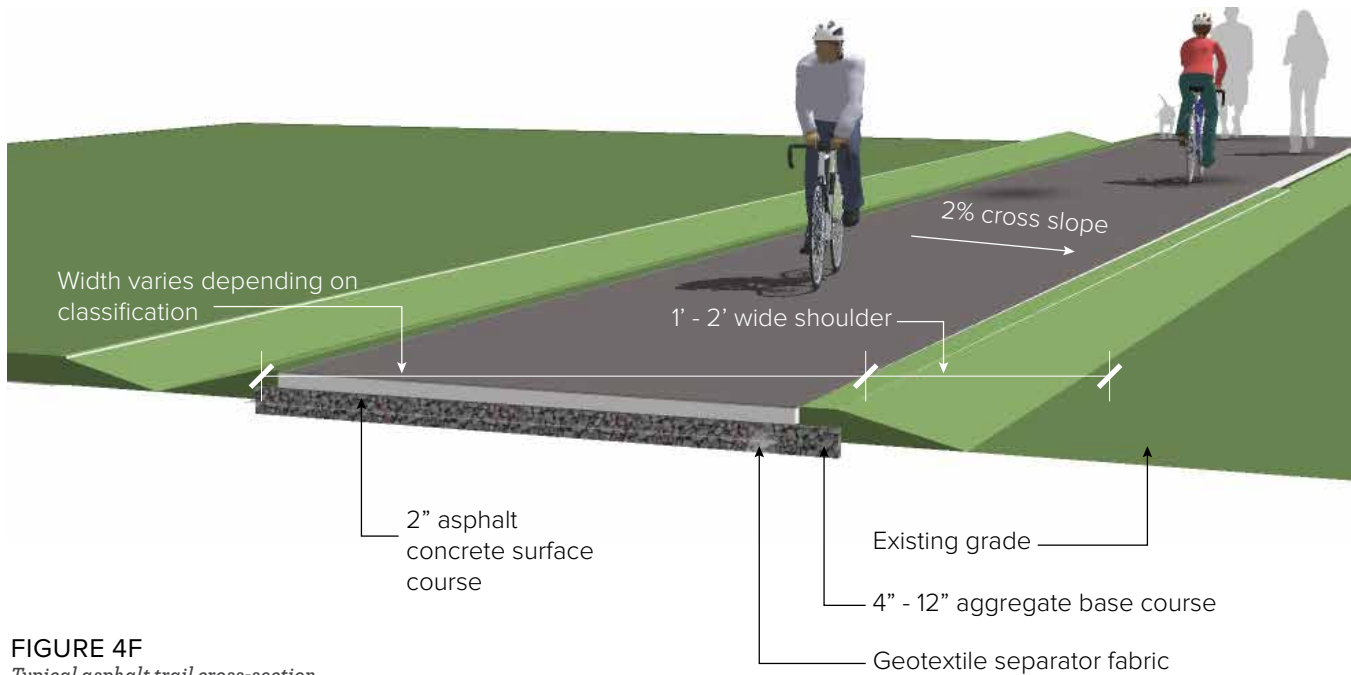

FIGURE 4F
Typical asphalt trail cross-section

Concrete

When cost allows, concrete is recommended because of its durability, longevity and lower maintenance requirements. Concrete is especially good in areas prone to frequent flooding, such as greenways. However, the hardness and jarring effect of this surface is not preferred by runners or cyclists. Concrete joints that are saw-cut rather than tooled tend to improve trail user experience. If constructed properly on suitable sub-grade, concrete has a life span of approximately 25 to 30 years.

4.6.2 Pervious / Permeable

The use of permeable paving when feasible supports the district's sustainability policy and has a number of positive environmental impacts, include lower storm water runoff and greater water infiltration rates. However, permeable paving is generally twice the cost of impervious materials to install and is recommended when site conditions are conducive to its use. As permeable paving continues to evolve and improve, the district will continue to evaluate its potential use in the trail system. The following should be considered for its use:

- » Conduct a feasibility study to determine site conditions and soil type
- » Environmental factors, such as the proximity to tree canopies or soil debris
- » Establishment of a regular and routine maintenance schedule to retain permeability, access for vacuuming debris and cleaning equipment, especially after storm events
- » Areas with proper drainage (not suitable in floodplain or areas with ponding or sedimentation)

4.6.3 Soft Surface

For purposes of this plan, natural surface trails are limited to bare earth (soil), gravel or crushed rock. Additional information about soft surface trails can be found in the district's PFP. When using crushed rock or gravel, trails in greenways benefit from screenings that contain about 4% fines by weight to compact and stabilize the trail's surfacing over time. However, an alternative surface should be considered when designing in flood-prone areas or steep terrain. When using soft surface trails:

- » Provide constant positive drainage to avoid ponding
- » Bench cut trail into slope without extensive removal of existing vegetation; build grade reversals and out-sloped elevations to encourage sheet flow across the trail
- » Design small-scale stormwater facilities along the trail to minimize erosion
- » Provide a longitudinal slope of 5% and a cross slope of 2%
- » Keep the trail available for year round use

4.7 AMENITIES



Amenities help distinguish district trails from others and help to enhance the trail user experience. This includes features such as site furnishings, bollards, signage, striping and fencing. It should be noted, however, that these amenities will not always be found along all district trails due to site constraints, trail classification, anticipated trail use and other factors. The following design guidelines for typical district trail amenities are intended as a tool for decision-making purposes related to new trail design or the enhancement of existing substandard trails.

4.7.1 Site Furnishings

Although district trails are regularly maintained and monitored, it is advisable to use vandal resistant construction and materials whenever possible. Site furnishings typical to district trails are highlighted as follows:

» Seating

- May include benches, seat walls, boulders, logs or other built features
- Typically located at trailheads, mid-block crossings, wildlife or natural area viewing locations and other areas of interest
- Provide adequate space for strollers and wheelchairs in a manner that does not impede trail use
- Seat walls shall include skate deterrents as appropriate

» Trash receptacles

- Preferably located at trailheads and mid-block crossings; may be considered near wildlife/natural area viewing locations if high use is anticipated
- Should not be located directly adjacent to benches and seating areas
- Should be located for ease of maintenance service and access



» Bike racks

- Typically located at parks along trail corridors, trailheads and where restrooms are located
- Should be located in a manner that does not impede trail use

» Drinking fountains and port-a-potties

- Preferably located at trailheads and parks along trail corridors; may also be considered near mid-block crossings if other locations are too far away
- New drinking foundations should include pet bowl and jug filler options
- Consider locations for ease of maintenance service and access

» Doggie bag dispensers

- Typically located at trailheads, mid-block crossings and near trash receptacles
- Mount on post with rules sign or on other surface as appropriate

» Kiosks

- Typically located at major trailheads or trail intersections
- Design adjacent to the trail near other site furnishings, such as a bench or trash receptacle

» Artwork

- Should be considered in the overall design of a trail project, as appropriate, and can be incorporated as part of the site furnishings (benches, bike racks, kiosks, etc.); as trail elements (bridge, boardwalk, walls, etc.); as stand-alone features (sculpture, mural, etc.); or as educational features (interpretive elements, environmental features, etc.)
- Consider using local artists to provide works that make the trail network uniquely distinct and representative of the district's character



4.7.2 Bollards

The use of bollards along district trails is intended to discourage motorized modes from using them. They are also used to distinguish district trails from trails provided by other public agencies (like school districts or cities) and private groups (like homeowner associations or golf/athletic clubs). The types of bollards used by the district and their unique characteristics are highlighted as follows:



» May include permanent, removable, collapsible or other site elements, such as boulders or logs

» Typically located at trailheads, mid-block crossings, maintenance access points and any other access point where vehicles may access the trail

» **Bollards are generally installed in groups of:**

- Two with removable or collapsible bollards
- Three with two permanent bollards and one removable or collapsible bollard

» Bollards are typically yellow in color and should consider the use of reflective tape

» **Permanent**

- Typically used on regional and community trails
- Locate in the gravel shoulder; where no shoulder exists, should be located 1-2 feet from edge of trail

» **Removable / Collapsible**

- Typically used on regional, community and neighborhood trails
- Located at trail centerline when used with permanent bollards on regional and community trails
- Locate at trail centerline when natural features create side barriers for neighborhood trails



» **Boulders / Logs**

- Typically located along street frontages at mid-block crossings, trailheads with parking areas and other potential unauthorized vehicle access points
- Often used in combination with bollards, especially if boulders are available on site or from another project
- Space uniformly to discourage vehicle entry but still allow for mowing and smaller sized maintenance equipment

4.7.3 Signage

All signage proposed along trails shall adhere to the district's approved Signage Master Plan. All signs visible from the public right of way must conform to MUTCD standards and guidelines, especially those signs that are directional and regulatory in nature. The district is also a partner in Metro's Intertwine Regional Trails Program, which provides guidance for identification and wayfinding signage for the interconnectedness of regionally significant trails, parks, natural areas and green spaces of the greater metropolitan area. The following list represents signage most commonly found throughout the district's trail system. Table 4D provides guidance for locating these typical sign types found along trails.

» Site Identification – Type A Sign Family

» Trailhead Identification – Type D Sign Family

» Regulatory – Type R Sign Family

» Directional and Safety – Type T Sign Family

» Identification

- Signs may include the Intertwine designation per Metro's Intertwine Regional Trails Signage Guidelines

» Regulatory

- Typically includes the R1 sign type at all trail sites, although other regulatory signs may be applicable
- R1 signs are typically located at all trailheads, mid-block crossings and all other trail entries and can be combined with A3 signs and doggie bag dispensers as appropriate
- Any other regulatory sign types are to be located at the appropriate location(s) within a trail corridor
- Follow AASHTO and MUTCD guidelines for signs at mid-block crossings and trail intersections

» Directional and Safety

- Follow Metro's Intertwine Regional Trails Signage Guidelines

» Educational

- Typically includes interpretive signage, although other signage may be applicable
- Interpretive signs are typically used when unique site features or educational characteristics exist; any such signage must adhere to the district's interpretive signage program as administered by its Natural Resources & Trail Management department.



TABLE 4D TRAIL SIGNAGE LOCATIONAL GUIDELINES

Level of Visibility (High to Low)	Sign Type	Type of Location	Site Placement	Comments
	Large ID Sign: A2	Oriented towards automobile driver	Main entrance OR prominent road location	Arterial street
	Standard ID Sign: A1	Oriented towards automobile driver	Main entrance OR prominent road location	Minor collector OR neighborhood street
	Trail ID Sign w/ map: D2	Major pedestrian entry point/trailhead/ existing park (ex: light rail station, parking lot)	On right side of trail	Requires orientation map
	Trail ID Sign: D1	Regular pedestrian entrance off arterial street	On right side of trail at a minimum of 10 feet inside trail OR at the apex of the "T" intersection if appropriate	Include directional strips with distance to prominent feature or trail connection
	Small ID/Rules Sign: A3/R1	At minor entry points, including street crossings	On right side of trail	Rules must be displayed at all entry points
	Trail Connection: T3	Where patron must exit trail and use on-street/sidewalk routes to close a gap in trail	On right side of exiting trail.	Requires connection map
	Pedestrian Directional: T5	Major directional at an internal trail intersection OR split	Placed at the apex of the "T" or "V" intersection	
	Trail Directional: T1	Minor directional at an internal trail intersection OR split	Placed at the apex of the "T" or "V" intersection	Visible/useful for users coming from different directions
	Trail Crossing: T4	Where trail makes direct connection across the street	On right side of trail where patrons cross	Must meet MUTCD standards

4.7.4 Striping

The use of striping is based on the district's Trails Management Program. However, trail projects that are federally funded will be required to follow AASHTO and MUTCD guidelines. The intent of the district's striping protocol of trails is to promote trail user safety by mitigating substandard trail conditions such as trail narrowing, limited sight-distance or sharp curves. It is not THPRD's intent to stripe all the trails throughout the district.



4.7.5 Fencing / Railing

Fences or railings along trails may be needed to prevent access to/from high-speed roadways or to provide protection along steep side slopes and waterways. Fences should only be used where they are needed for safety reasons. They should be placed as far away from the trail as possible; with a minimum offset of two feet. Many of these principles apply to cut-sections of trail where retaining walls are required: minimum two feet offset, with a rub-rail whenever possible. Whenever fencing or railing is used in a trail corridor, the following fencing types should be considered:



» General considerations

- The district does not install fencing for property owners; in instances where it is required, the district shall place such fencing on the property owner side of the property line and the property owner is responsible for fencing after installation
- The district does not install fencing to delineate natural area boundaries unless deemed necessary by the Natural Resources & Trail Management department
- Fencing should be located within a mow strip as deemed necessary by the Maintenance Operations department regardless of fencing type

» Split-rail

- Preferably used for site boundaries, natural areas and safety; it is the district's preferred fencing type in most situations where delineation between activities or uses is needed
- When used for site boundaries, fencing should be placed on district side of the property line for ease of maintenance
- Generally 3-4 feet tall, having two rails; fences having three rails are considered "heavy duty"
- Consider along trails having steep downhill slopes or at top of retaining walls
- Locate within a bark mulch mow strip as appropriate

» **Chain-link**

- May be used for site boundaries and safety
- Generally 3-6 feet tall depending on situation
- May be galvanized or vinyl-coated depending on location; where vinyl-coating is needed, it should be black
- Consider use of privacy slats as appropriate

» **Welded wire or field fencing**

- Typically used for natural areas
- Generally 2-5 feet tall
- Consider along natural areas where access by park users are not desired, such as mitigation or restoration areas
- Generally used on a temporary basis

» **Ornamental / Decorative**

- Ornamental or decorative fencing may be considered in those instances where a higher level of design is desired, such as main trailheads located at parks or other district facilities

» **Safety railing**

- Typically used along boardwalks, top of retaining walls and steep slopes where the trail surface is 30 inches or more above ground surface
- Minimum height of 42 inches
- Openings in the railing must not exceed 4 inches in width
- Where a cyclist's handlebar may come into contact with a fence or barrier, a smooth, 12 inch wide rub-rail should be installed at a height of three feet

4.7.6 Landscaping

Generally THPRD does not design or install landscaping as part of a trail project unless it relates to mitigation. However, in some situations trail projects and residential developments are combined that require aesthetic landscaping. Use of native and drought tolerant species should be considered whenever possible, especially in locations where irrigation is not provided.

» Locations

- Typically located at trailheads and where separation is needed between the trail and other uses, such as roadways, sidewalks and pathways
- Shall include native and drought tolerant plant species as appropriate, but may include ornamental plant species where irrigation is available
- Trees to be planted no closer than 10 feet from the edge of trail surfacing
- Shrubs to be planted no closer than 5 feet from the edge of trail surfacing
- Groundcovers and grasses to be planted no closer than 3 feet from the edge of trail surfacing
- Existing landscaping and trees must be protected and incorporated into trail development/enhancement whenever possible

» Ornamental grasses

- Generally require minimal maintenance once established and are typically used in landscape buffers separating the trail from roadways and sidewalks

» Groundcovers

- Generally require minimal maintenance once established and are typically used in landscape buffers separating the trail from roadways and sidewalks.
- Typically used in areas where turf grass is not appropriate, such as on steep slopes, and landscape buffers separating the trail from roadways, or sidewalks.

» Shrubs

- Consider native plant species along park boundaries, natural areas and other locations where buffers are needed

» Trees

- Avoid the use of trees having excessive litter and debris
- Consider a tree's ultimate size and growth habit to ensure proper placement for trail designs
- Consider using root barrier in areas where existing trees are located closer than 10 feet to the edge of trail and/or when a large number of trees will be planted
- Refer to the local jurisdiction street tree guidelines for trees to be planted along trails, sidewalks or rights of way

» **Low maintenance guidelines**

- Avoid the use of plant species that produce excessive litter and debris, such as fruit, pods or cones
- Avoid the use of plant species susceptible to wood rot, disease or limb breakage (“weak wooded”) in areas of high trail use
- Avoid siting plant species that overhang trails or have root systems that could impact trail surfaces

4.8 BRIDGES AND BOARDWALKS

Bridges and boardwalks are structures that span over sensitive natural areas or inundated waterways to limit potential environmental impact. They are typically used when crossing small creeks and wetlands. Boardwalks range in length and can span as little as 10 feet or stretch for longer distances depending on site conditions. Bridges are used where greater lengths are required to span sensitive areas or when the objective is to reduce impacts to the floodplain.



FIGURE 4G
Typical bridge/boardwalk cross-section.

Bridges and boardwalks are commonly constructed of wood, steel or concrete with recycled plastic components. Wood is the most cost effective, versatile and relatively easy to install. Special consideration must be taken when using pressure treated lumber over waterways. While steel is a more expensive option, it can be purchased as a prefabricated kit, and can expand extensive lengths where other materials cannot. Modular concrete boardwalk systems are gaining popularity due to their low-impact installation methods and durability within wet areas. Recycled plastic is popular for its material durability, but is typically limited to non-bearing uses such as decking and handrails. Bridge and boardwalk designs must consider the intended use and be built from materials that is aesthetically and structurally appropriate.

4.8.1 Boardwalks

General considerations for the use of boardwalks include:

- » Clear span width must be a minimum of 14 feet for regional trails and 12 feet for community trails. Wider widths are preferred in areas with higher anticipated use and whenever railings are used
- » Use of a 6 inch curb rail is recommended. A 42 inch guardrail is required at locations where there is a 30 inch or greater elevation difference in the boardwalk surface and the ground/water surface below
- » Design to structurally support 5 tons of capacity depending on emergency vehicle access and maintenance requirements
- » Evaluate footing types to include uplift as well as loading consideration for flood events.
- » Consult a structural engineer for member sizing, headwall and post footing design
- » Give careful consideration to selection of decking material to minimize slippery conditions (see Table 4E)
- » Follow all local, state and federal permitting requirements where boardwalks are located within wetlands; construction in wetlands is subject to jurisdictional regulations

4.8.2 Bridges



Bridges are most often used to provide user access over natural features such as streams, creeks and wetlands, where a boardwalk is not an option. The type and size of bridges can vary widely depending on the trail location, site conditions and jurisdictional requirements.

The biggest factor in determining the width and load capacity for trail bridges, as well as boardwalks, is the project requirements and the maintenance program, including emergency/ security access. A developed site and maintenance access determines trail widths and bridge/boardwalk capacity. The funding source is also a determining factor, since federally-funded trails must adhere to the most stringent design standards.

Below is a list of general guidelines for the design of bridges for future trail projects. Many of these considerations are also applicable to design of boardwalks.

» **When constructing a federally funded project, design criteria for the width of bridges are established by AASHTO**

- Standard width: 14 feet, unless a design exception is granted
- Standard for a 'live load' for pedestrian and bicycle bridges: 85 psf (pound per square foot), plus any additional vehicle loading when used by maintenance or emergency/security vehicles
- For bridges greater than 10 feet wide, the vehicular design load is for an HS10 truck
- Bridges must also be designed to resist lateral forces from wind and earthquake as described by AAHSTO

» **Projects funded from other sources:**

- Bridge width for regional and community trails: 2 feet wider than the paved trail approaching the structure
- In special situations, a design exception is required in order to allow the width of a bridge to match the width of the trail connecting to it. Refer to Section 4.3 above for additional information about design exceptions

- » Vehicle-rated bridges will only be specified when they are justified for maintenance, emergency or security access. The justification will be dependent on the site and maintenance program. If determined to be used for vehicle access, a bridge should generally be able to support the weight of a light duty emergency vehicle
- » A goal of the district is to reduce, restrict and limit the need for maintenance vehicle access over bridges by placing trash receptacles and other 'high maintenance' site amenities close to the main access points
- » If maintenance or emergency/security staff need access to a site's interior, make sure the trail intersections have wide radii and gentle turning movements; i.e., no 90 degree turns or 'T' intersections
- » Provide a minimum of one 8 foot wide trail to one end of a bridge or boardwalk for routine maintenance
- » If site amenities or structures are in a site's interior and will require vehicle access for routine maintenance (e.g., play equipment, shelter, bridge/boardwalk, sport court, etc.) then a trail with adequate width and proper load capacity must be provided
- » Adjust maintenance service delivery measures and design the site to reduce vehicle trips or access into the site's interior
- » Some sites may have reduced trail widths or surfacing modifications to meet the intent of the NRFP, which calls on staff to: "Plan, provide and manage appropriate maintenance access routes, where required, that minimize impacts to natural resource areas by designing them with minimal impervious surfaces and widths."

4.8.3 Materials

The district has traditionally used natural wood for its bridges and boardwalks. Over the past several years, the use of recycled plastic lumber has been used in an effort to be more sustainable. Other materials may also prove to be useful, depending on site conditions, costs and other factors. The following matrix in Table 4E can be used to determine an appropriate surfacing treatment based on a variety of site characteristics. Please note that the following should also be used when determining surfacing materials for stairs or overlooks.

As new and/or improved surfacing options become available, they should be evaluated in the same manner described in Table 4E. Consult the district’s sustainability policy prior to making decisions about surfacing materials.

TABLE 4E
BRIDGE / BOARDWALK
SURFACING MATRIX

		Trail Conditions (3 = Better Suited / 1 = Lesser Suited)								
		Shaded Conditions	Sun Conditions	Vehicle Access	Active Use (jog/ bike)	ADA	Cost	Ease of Maintenance	Wetlands/ Water	Durability/ Sustainability
Trail Surfacing	Ipe	1	3	TBD	1	3	1	3	3	3
	Treated Wood	2	2	2	2	3	3	2	1	2
	American Plastic Lumber	2	2	1	3	3	2	2	3	2
	Fiberglass Grating	3	2	1	2	2	1	3	3	2
	Metal Grating	3	3	1	2	2	1	3	3	2
	Concrete Slab	TBD								

4.9 MID-BLOCK CROSSINGS

The following provides design guidance for roadway intersection treatments. The guidelines presented in this plan represent conceptual recommendations. Specific roadway intersection treatments will be based on further engineering analysis conducted by a registered engineer and review by the respective jurisdictional agency (City of Beaverton or Washington County).

The approach to designing crossings at mid-block locations depends on an evaluation of vehicular traffic, line of sight, trail traffic, use patterns, vehicle speed, road type, road width and other safety issues such as proximity to major attractions. When space is available, use of a median refuge island can improve user safety by providing pedestrians and bicyclists the space to perform a safe crossing.

Regardless of whether a mid-block crossing is non-signalized or signalized, the crossing should do the following:

- » Be a safe distance (based on travel speeds and sight lines) from adjacent intersections and not interfere (or be interfered) with vehicle traffic flow
- » Be located on flat topography to increase motorist visibility of the trail crossing
- » Be as close to perpendicular (90 degrees) to the roadway as possible
- » Use signage and striping to warn trail users of the upcoming roadway is strongly recommended
- » Maintain clear sight lines between trail users and motorists by clearing or trimming vegetation obstructions
- » Provide a center median refuge if the crossing is more than 75 feet from curb to curb or as directed by the agency with jurisdiction

When a proposed trail mid-block crossing is within approximately 300 feet of an existing signalized pedestrian crosswalk, the trail should be routed to it. This will avoid potential traffic signal operation problems and reduce motorist confusion. For this alignment to be effective, barriers, signage or offset trail alignments may be needed to direct trail users to the signalized crossing. If no pedestrian crossing exists at the signal, modifications may be required to accommodate a safe crossing.

4.9.1 Non-Signalized Crossings

Non-signalized crossings are most likely to occur at local/neighborhood roadways and some collector roadways. Non-signalized crossings may be appropriate when maximum traffic volumes are less than 9,000-12,000 ADT (average daily traffic) vehicles and maximum travel speed is 35 MPH (miles per hour). Non-signalized crossings may be appropriate with traffic volumes up to 15,000 ADT on two-lane roads and up to 12,000 ADT on four-lane roads, if a median refuge island is provided in both scenarios.



FIGURE 4H
Mid-block non-signalized trail crossing of a local/residential street.

Typical treatments at these crossings include:

- » Continental striping, if allowed by the agency with road jurisdiction
- » Signage
- » Sidewalk improvements, such as ADA transitional ramps
- » Vehicle bollards at trail access points
- » Street lighting
- » Median refuge islands if appropriate
- » Speed hump or raised crosswalk on roadways with low to moderate traffic volumes (under 12,000 ADT) and a need to control traffic speeds

Trail design features that may be used to warn trail users of an upcoming roadway crossing may include the following:

- » Curves in the trail to help slow trail users and raise awareness of oncoming vehicles
- » Detectable warning strips help visually impaired pedestrians identify the edge of the street
- » Signage



4.9.2 Signalized Intersections

Signalized crossings are most likely to occur at arterial roadways and some collector roadways. There are different scales of signalization, depending on traffic capacity, speed and trail user volume.

A signalized intersection should include all of the same treatments as a non-signalized crossing, plus the addition of a traffic control device. The addition of a traffic control device, such as a traffic signal or flashing beacon, provides increased protection for trail users.

Typical traffic control devices used by the district, as approved by the City of Beaverton or Washington County, include the following:

- » Rectangular Rapid Flashing Beacons (RRFB) act as lit warning devices to supplement the trail crossing warning signs at uncontrolled approaches.



- » Pedestrian Activated Hybrid Beacons (also known as HAWK signals) alert motorists to stop when trail users are crossing mid-block. When not activated, the signal is dark. When activated, the overhead signal begins flashing yellow, followed by solid yellow, advising motorists to prepare to stop. The signal then displays two solid reds allowing bicyclists and pedestrians to safely cross. Finally, an alternating flashing red signal indicates that motorists may proceed when safe, after coming to a full stop.
- » Full Traffic Signal is a typical traffic signal with a green light always shown. When activated by a bicyclist or pedestrian, the light changes to yellow, then red; allowing the user to safely cross with a “Walk” indicator. Full traffic signal installations must meet MUTCD pedestrian standards for schools or modified warrants, which include: being located where a shared use path intersects with a high volume, high speed roadway, with traffic volumes exceeding 15,000 ADT and vehicle speeds exceeding 40 MPH.



Unlike non-signalized crossings of local or residential street, each signalized crossing (regardless of traffic speed or volume) requires additional review by a registered engineer and the agency having jurisdiction of the roadway to identify sight lines, potential impacts on traffic progression, timing with adjacent signals, capacity and safety.

4.9.3 Grade-Separated Crossings

Grade-separated crossings may be appropriate where a path intersects with a high volume, high speed roadway, with traffic volumes exceeding 25,000 ADT and vehicle speeds exceeding 45 MPH. Due to considerable cost and complexity of design, grade separated crossings are limited to unique situations and usually in partnership with a local jurisdiction. Typical grade-separated crossings include:

- » Undercrossing
- » Overcrossing



Safety and ADA accessibility is a foremost concern with both types of crossings. In undercrossing situations, the trail user may be temporarily out of sight from public view or experience and environment with poor visibility. To ensure safety and security concerns are met, both types of crossings must be spacious, well-lit and visible to public view. Flooding and/or standing water may also pose a problem for undercrossings requiring the need for periodic cleaning and/or draining (especially after storm events for those undercrossings that may be located within greenways).

4.10 RISK, SAFETY AND SECURITY

4.10.1 Crime Prevention Through Environmental Design (CPTED)

Along with the desire of creating well-designed trails for its residents, the district is also intent on ensuring the safety and security of its trails and facilities. To help make this possible, the following fundamental CPTED principles should be considered.

» Access

- Establishment of clearly defined trail entries and facilities for trail users to easily access and move about
- Establishment of clearly defined trail boundaries to differentiate between public and private spaces

» Visibility

- Maintain open sight lines throughout a trail corridor in order to promote natural surveillance and the “see and be seen” concept

4.10.2 Scan Analyze Response Assess (SARA)

SARA is a four-step process to quickly address situations that occur in the field, and is described as follows:

- » **Scan:** observe what the situation is, to determine what possible factors are the cause
- » **Analyze:** determine what possible solutions could be implemented to correct
- » **Response:** implement solution
- » **Assess:** evaluate if the solution corrected the situation or if additional measures need to be taken

4.10.3 Sight Distance

Maintaining adequate sight distance for trail users is key in providing a safe trail system. This includes ensuring visibility for (and of) trail users at mid-block crossing locations, steep slopes and switchbacks, tight curves, wooded areas and any other situation where sight lines could be impaired due to site conditions.

4.11 MAINTENANCE & OPERATIONS

Maintenance operations of district trails fall into one of two categories: park maintenance or natural resources maintenance.

- » Park maintenance is responsible for hard surface trails in order to provide safe and open access opportunities for people to recreate, travel, play and enjoy the outdoors
- » Natural resources maintenance is responsible for soft surface trails in order to lessen human impacts and allow natural processes to continue, while providing safe passage for people where appropriate

Please refer to the district's PFP for additional information relating to park maintenance and the NRFP for additional information relating to natural resources maintenance. Trail maintenance operations fall into both categories and consist of the following:

4.11.1 Trail Management Program

THPRD's Natural Resources & Trails Management department administers the district's approved Trails Management Program. The goal of the Trails Management Program is to provide high quality trail systems that safely and sustainably connect people and communities. When the program is successful, these conditions will be met:

- » Trails will meet safety standards
- » Trail stakeholders, such as district departments and volunteers, will know their role
- » Trail information will be available to the public

Trails management is a team effort, requiring the cooperation of multiple departments. The Natural Resources & Trail Management department has the lead role to coordinate the strengths of trained volunteers and the Maintenance Operations, Design & Development, Risk Management, and Security Operations departments to recognize and recommend physical and service improvements to our district's trail system. Please refer the program document for more detailed information about trails management.

4.11.2 Safety Inspection Training Program

As part of the Trails Management Program, the district uses a Safety Inspection Training Program. This program trains district staff to be aware and able to identify potential hazards along the trail system, such as overhanging tree limbs, deteriorating trail surfaces or substandard trail sections. These inspections are conducted annually and are prioritized accordingly. Those hazards posing immediate safety concerns to trail users are moved to the top of the list and addressed immediately. All other potential hazards are rated using a risk assessment matrix for future inclusion in the district's capital maintenance replacement program. The Trails Analysis Form is included in the Appendix for reference.

4.11.3 Maintenance Standards Manual

In addition to the district's Trails Management Program, additional standards and guidelines for trail maintenance can be found in THPRD's Maintenance Standards Manual. Please refer to this manual for district standards and guidelines related to trail maintenance practices. This manual is intended to work in tandem with the Trails Management Program and helps implement many of trail management principles.

4.11.4 Maintenance Vehicle Access Guidelines

In general, regional and community trails should be designed with maintenance and emergency vehicle access in mind. This includes not only the paved trail, but also any bridges or boardwalks along a trail corridor. However, not all bridges and boardwalks need to be vehicle rated if adequate access can be provided from either end of a bridge or boardwalk. Additional guidance can be found in Section 4.8 above.



IMPLEMENTATION & DEVELOPMENT

5.1 PRIORITIZATION CRITERIA FOR TRAIL DEVELOPMENT

The 2006 Trails Master Plan established eight goals for the district's trail system:

- » Providing recreation opportunities
- » Trail development and regional connections
- » Access
- » Community linkages
- » Amenities
- » Maintenance and emergency access
- » Preservation
- » Funding

These eight goals provided the framework in the establishment of the prioritization criteria discussed in the next paragraph.

With the help of the Trails Advisory Committee and staff, selection criteria were developed to establish the framework for the trail prioritization criteria matrix, Table 5A below. The criteria were used to establish priority recommendations for new trails and upgrades to existing substandard trails. These priorities will be implemented by the district's board of directors through the annual budgeting process. Priorities will largely be set based on the funds that are available and applicable for each category (i.e. capital funding to be used for replacement projects on existing trails, site development changes used for new trail improvements).

The spring 2015 survey indicated that respondents believed the district should allocate its resources in the following order: 1) constructing new trails and 2) upgrading existing substandard trails. Although not specifically asked, it can be inferred that land acquisition for new trails should be a priority of the district because of the desire by survey respondents to see new trails constructed.

As such, there may be extenuating circumstances when land acquisition will take precedence to new trail development or enhancement. Land acquisition is often driven by market conditions, a property owner's willingness to sell, public or private partnerships and other factors. The district will continue to actively pursue land for trails in those areas where no service currently exist, including current and future service areas. In areas currently served, the district will be most interested in acquiring land that will fill gaps in or extend the existing trail network.

Table 5A represents thirteen prioritization criteria that will be used to determine how the district will use its resources for trail development, whether it is the enhancement of existing substandard trails or the development of new trails. In order to better prioritize trail projects throughout the district, each criterion is weighted based on district policies and desired outcomes. As projects arise, they will be scored and placed in one of two priority areas. Projects scoring 30 or higher will be considered Tier I projects, or high priority projects; projects scoring 29 or lower will be considered Tier II projects, or medium priority.

TABLE 5A TRAIL PRIORITIZATION CRITERIA MATRIX

Criteria	Point Scale (3=High / 1=Low)		
	3	2	1
Citizen-Initiated Project Support	Generally Supported by Residents Adjacent to Trail	Generally Supported by the Community At-Large	Neutral or Generally Not Supported
Located in Environmental Justice Area* or CDBG Designated Area	Within a Significantly Above Average Area	Within an Above Average Area	Within an Average or Below Average Area
Located in an Underserved Area	No Trail Access		
(within 1-mile)	Limited Trail Access		
(within 1-mile)	Adequate Trail Access (within 1-mile)		
Locational Proximity to Residents Served	Surrounded by In-District Residents	Partially Surrounded by In-District Residents	Surrounded by Out-of-District Residents
Number of Residents Served	More than 1,000	500 to 1,000	Less than 500
Overcomes Barriers	Major Improvement		
(off-street)	Moderate Improvement	Minor or No Improvement	
(on-street)			
Potential for Access to Scenic / Natural Areas	More than 75% of the Trail Corridor	30% to 75% of the Trail Corridor	Less than 30% of the Trail Corridor
Property Ownership	District Owned (fee-simple or easement)	District Owned & Public Right of Way	Public Right of Way (on-street)
Proximity to Major Destinations / User Generators (parks, schools, transit, commercial centers, etc.)	Less than ½-Mile	½-Mile to 1-Mile	More than 1-Mile
Regional Benefits	Improves Access to Regional Areas of Interest	Improves Access to Local/Community Areas of Interest	Improves Access to Neighborhood Areas of Interest
Trail Connectivity	Fills a Gap in the Trail System	Improves a Substandard Portion in the Trail System	Does Not Fill a Gap or Improve a Substandard Segment in the Trail System
Trail Ease of Implementation	Minor Site Work	Moderate Site Work	Major Site Work
Staff Judgment	Does this project make sense in this location? Does this project fill a specific need or service? How long has this area had an unmet need?		

*Based on information produced by Metro

It should be noted that much of the district's future regional and community trail system is located within environmentally sensitive areas, such as creek corridors. These trail corridors have been identified on the 2015 Trail System Map (Figure 3C) as study areas, which mean they do not have a defined trail alignment at this time.

Instead, these study areas will be analyzed using both the Trail Prioritization Criteria Matrix above (Table 5A) and the district's NRFPs Site Development Suitability Criteria (Table 5A of that plan) to determine an appropriate trail alignment. This could result in the recommendation that a trail, or portion of a trail, be located outside of the resource area (possibly as an on-street connection). Where the TFP trail prioritization criteria indicates a high priority for trail development and the NRFP site suitability criteria indicates a high priority for natural resource function, it shall be up to the district's management team and/or board of directors to determine which priority takes precedence.

For those trail corridors located within an environmentally sensitive area but not identified on the trail system map in a study area, this same feasibility analysis will take place in order to determine the most appropriate trail alignment.

5.1.1 New Trail Construction

Prioritization of new trail development projects is based on the trail prioritization criteria identified in Table 5A. Prioritization also takes into consideration the district's existing trail network as shown in Figure 3C. Tables 5B and 5C identify development priorities for future trails.

5.1.2 Existing Trail Enhancements¹

Prioritization of enhancement trail projects is based on the trail prioritization criteria found in Table 5A. Prioritization also takes into consideration the district's existing trail network as shown in Figure 3C. In many cases, these represent trails that are narrower than district recommendations or have bridges or boardwalks that are narrower than the trail approaches. In either case, these scenarios cause pinch points along the trail system, increasing safety concerns and decreasing trail functionality for trail users. Tables 5D and 5E highlight enhancement priorities for existing trails.

¹ Existing substandard trail improvement projects that increase capacity and functionality – such as increased widths and curb cuts – are not SDC eligible. Funding for these types of projects is generally associated with grants, bonds or other funding sources. In limited circumstances, these projects may be associated with a maintenance project – such as a trail overlay – and funded through the General Fund.

TABLE 5B TIER I (HIGH) PRIORITY PROJECTS

Trail Name / Segment Number	Description
Beaverton Creek Trail #1	THPRD Boundary to 185th Avenue
Beaverton Creek Trail #2	185th Avenue to 170th Avenue
Beaverton Creek Trail #3 & #4	Westside Trail to Hocken Avenue
Waterhouse Trail #4	Willow Creek Greenway to Cornell Road

TABLE 5C TIER II (MEDIUM) PRIORITY PROJECTS

Trail Name / Segment Number	Description
Beaverton Creek Trail #3	170th Avenue to Westside Trail
Cedar Mill Creek Trail #4	114th Avenue to Foegen Park
Fanno Creek Trail #5	Scholls Ferry Road to 92nd Avenue
South Johnson Creek Trail #5	Lowami Hart Woods to Brookhaven Park
Westside Trail #12 – #14	Merlo Light Rail Station to Sunset Highway
Westside Trail #15 – #19	Sunset Highway to THPRD Boundary
Westside Trail	Sunset Highway Crossing
Remaining trail segments to be determined	

TABLE 5D TIER I (HIGH) PRIORITY PROJECTS

Trail Name / Segment Number	Description
Trail Name / Segment Number	Description
Waterhouse Trail #6	Jocelyn Drive to West Union Road

TABLE 5E TIER II (MEDIUM) PRIORITY PROJECTS

Trail Name / Segment Number	Description
Westside Trail #2 – #4	Scholls Ferry to Nora Road
Westside Trail #5	Rigert Road to Hart Road
Westside Trail #6	Hart Road to Burntwood Way
Remaining trail segments to be determined	

5.2 LAND ACQUISITION / RIGHT OF WAY

THPRD's Planning and Design & Development departments use its Acquisition Parameters Guide, which outlines how the district acquires properties. This includes land acquired as fee simple, easements and donations. As part of its due diligence, the district uses an extensive process of inventorying potential properties for acquisition. This process is highlighted in the following illustration (Figure 5A) and helps to determine site suitability for trail development. This process, initially created and used as part of the 2008 bond measure land acquisition strategy, has been updated to include the trail prioritization criteria outlined in the above.

In addition to the flow chart, a number of questions are also asked when determining acquisition and prioritization of potential trail sites. These include the following:

- » Does it make sense to develop a trail at this location?
- » Does this site fill a specific need or service?
- » Is this a unique opportunity?
- » Can the site fulfill its intended purpose?
- » What are potential costs for future trail development (utilities & infrastructure, trail constructability, etc.)?
- » Does it serve a multipurpose opportunity for a trail, park, natural area and/or athletic facility, or is it just a trail?
- » Is it a key piece to expand an existing trail?

As opportunities arise, properties will be scored and placed in "high", "medium," or "low" suitability trail sites.

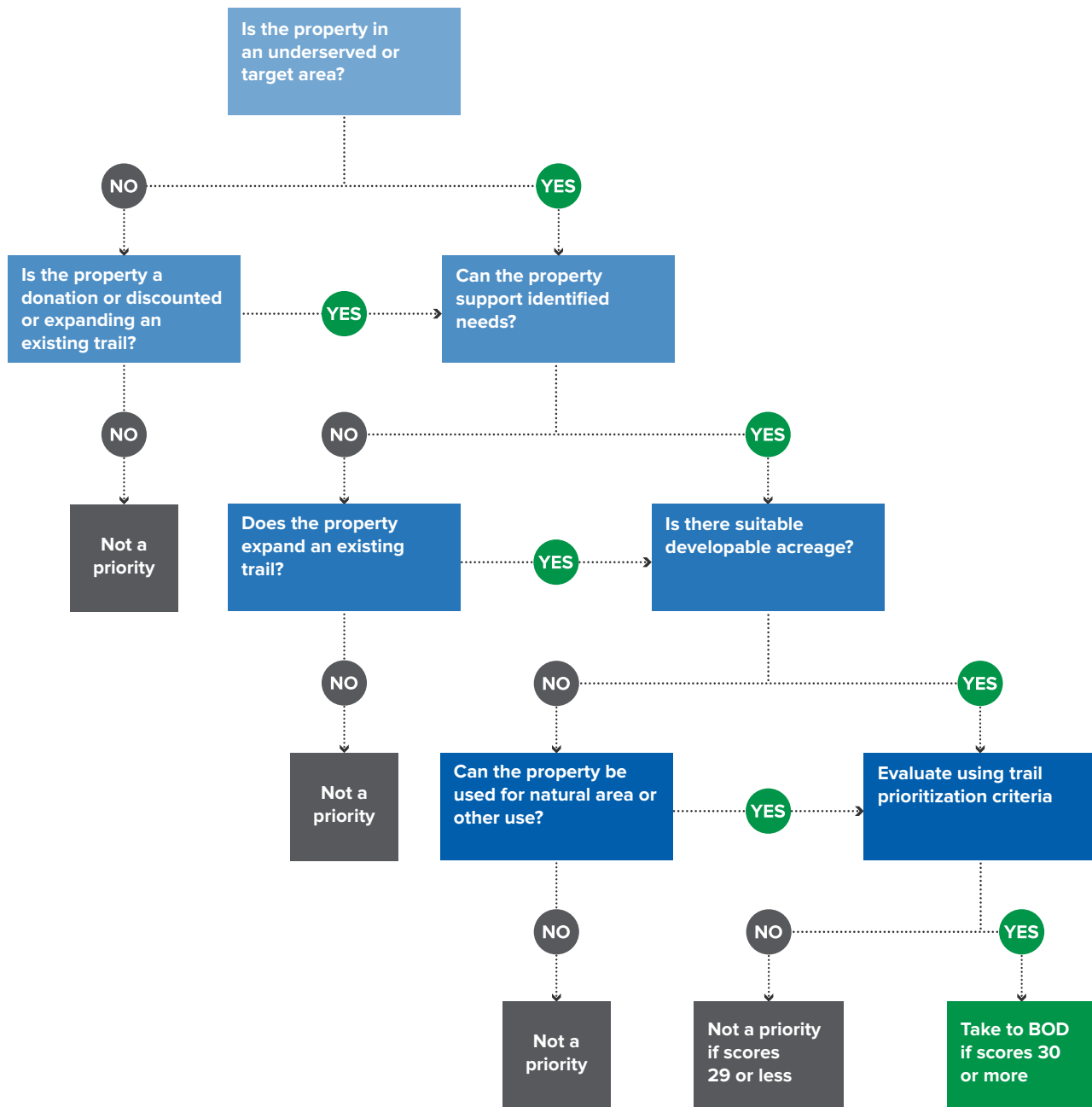

FIGURE 5A
Land Acquisition Site Suitability Flow Chart.

5.3 FUNDING STRATEGIES

5.3.1 Capital Improvement Program (CIP)

The district's capital improvement program (CIP) is a combination of deferred maintenance capital projects and SDC development projects. Additionally, the CIP takes into account the project priorities outlined above. Projects in the CIP are then funded through the district's budgeting process with either general funds or SDC funds. Grants, partnerships, donations and volunteers may also be solicited to help fund projects identified in the CIP in an effort to maximize district resources.

5.3.1.a Property Tax / General Fund

The district's primary funding source is property tax revenue. This revenue goes into the district's general fund and is then allocated for capital projects and maintenance operations on an annual basis. This fund is typically prioritized toward capital replacements.

5.3.1.b System Development Charges / SDC Fund²

The district's main source of funding for new trail improvements comes from its system development charges (SDC) fund. Since 1997 the district has collected fees on new residential and commercial development occurring within its service area. These fees can only be used for new trail development or improvements to existing trails that expand capacity necessitated by new development. SDC funds cannot be used for capital replacement or maintenance purposes.

5.3.2 Developer SDC Credit Projects

In lieu of paying SDC fees at the time of development, developers may enter into a memorandum of understanding (MOU) to construct trail improvements for the amount of estimated SDC fees that would normally be charged. The MOU outlines specific trail improvements to be constructed for which credit will be issued. The MOU also includes language to ensure that such trail improvements meet district design standards and guidelines.

² Existing substandard trail improvement projects that increase capacity and functionality – such as increased widths and curb cuts – are not SDC eligible. Funding for these types of projects is generally associated with grants, bonds or other funding sources. In limited circumstances, these projects may be associated with a maintenance project – such as a trail overlay – and funded through the General Fund.

5.3.3 Grants

Grant sources include private foundations, public agencies, such as the Oregon Parks and Recreation Department, the Oregon Department of Transportation, Metro, and other agencies. Grants can be used to acquire land, fund an entire trail development and/or just a portion of a trail, such as a bridge, signage or trailhead amenities. Grants can also be used for new trail development or enhancement of existing trails and facilities. The district will typically use SDC funds as a local match in order to leverage grant funds.

5.3.4 Donation / Volunteer / Partnership

In certain instances, trail improvements are donated to the district or provided to the district. This could include land, materials, products and/or labor for the construction or maintenance of trail improvements. In most instances, this occurs in conjunction with improvement projects of other public agencies, such as Metro, Washington County, Clean Water Services or the City of Beaverton. In some instances, trail improvements can come from private development or community groups seeking improvements of trail facilities in their neighborhoods.

5.3.5 Bond Funding

The district may pursue the issuance of bonds if approved by voters during a general or special election. Bond funds can be used for a variety of projects based on how the bond is crafted, including land acquisition, new trail development, redevelopment of existing trails, capital replacements or a combination of these items. Bond funds can be short-term or long-term, and can be used for specific projects or many different projects.



SUCCESS MONITORING

6.1 PERFORMANCE MEASURES

Perhaps the simplest measures for gauging district progress are tracking:

- » Number of master plans completed
- » Miles of new trails constructed
- » Number of capital replacement projects completed
- » Miles of substandard trails enhanced

While the district will monitor these items, they cannot be stand-alone measurements as many factors can influence targeted outcomes. Budget constraints, shifts in priorities, environmental considerations and other such factors can impact the length of time to complete projects or acquire land.

Additional performance measures that can be used by the district include:

- » Trail system completion
- » Trail system connectivity
- » Access and proximity to population
- » Trail maintenance
- » Trail user satisfaction
- » Trail user profile
- » Trail user counts

6.2 MONITORING PROCEDURES

The district will use a variety of methods to monitor its successes, or shortfalls, in achieving its expectations. Monitoring of expectations will occur on an annual basis or a multi-year basis depending on outcomes being monitored. The following table identifies specific monitoring procedures to collect data on those performance measures listed above.

Any successful monitoring process includes effective communication of outcomes. As part of the district's effort, it will provide periodic updates or reports to the management team and board of directors on key elements in the monitoring process, including miles of trails completed, identification of most heavily used trail segments (based on trail counts) and where critical gaps in the trail system exist.

Communication with the public is also important and may include updates on initiation of trail master planning, new trail construction and completion of trail development projects. Project updates and highlights of specific trails may be included on the district's website, in its activities guide and/or in its monthly e-newsletter and quarterly newsletter. Any communication intended for the public needs to be coordinated with the district's Communications & Outreach Division.

TABLE 6A PERFORMANCE MEASURES AND MONITORING PROCEDURES

Performance Measure	Monitoring Procedure(s)	Additional Notes
System Completion	GIS evaluation	Maintain GIS database of trails to include attributes such as trail surface, trail width and date of construction
Trail System Connectivity	GIS-based model	Use GIS model developed through Rails to Trails Conservancy Trail Modeling and Assessment Program (T-MAP) to inventory and analyze the district's trail system in relation to regional and nationwide trail networks
Access and proximity to population	GIS evaluation	Determine locations of access, quality of access using GIS to determine percentage of households or percentage of population within a half mile of accesses
Trail Maintenance	Routine operations	Conduct systematic risk assessment (inspections of railings, bridges, surfaces, signage, etc.; evaluation and removal of debris; emergency response protocol; tracking of incidences and safety issues; vegetation control)
Trail Maintenance	Remedial operations	Correct significant defects (resurfacing, repainting, repairing, etc.)
User Profile/ Satisfaction	Survey	Gather data on type of use, amount of use, distance traveled, amount of money spent, where money is spent. Information can feed into an economic and health impact assessment. Multiple examples of these analyses can be found around the country and the T-MAP program is also developing these national tools that can be used here
Counts	Field counts	Automated or manual calculation of ADT



6.2.1 Short Term Monitoring

One of the easiest ways for the district to gauge whether it is improving its trail system is through its annual maintenance inspection process. Each year all district assets, including trails, are evaluated and placed into the deferred maintenance database. This database is used to help prioritize capital replacement projects during the budgeting process. As replacement projects occur, including updates to trail facilities and amenities, these items can be tracked against the trail inventory completed in spring 2015.

Trail user surveys are another way the district can monitor whether or not expectations are being met or if access to trails is improving. Although these types of surveys are not scientific or statistically valid, they do provide a method of getting immediate feedback from the people on the trails. Analysis of trail counts is another method for tracking trail usage and can often reinforce information gathered from user surveys and inspections.

6.2.2 Long Term Monitoring

Because projects such as master plans, new trail development, and existing trail enhancement often take more than one year to complete, it is more effective to monitor for success on a 3-5 year basis. Tracking projects identified in the district's annual budget is one of the easiest ways to track progress, comparing projects completed on time versus those that get delayed or eliminated.

Trail user profiles, and access to user populations, and other demographic information are also better gauged on a long-term basis. These types of analysis tend to be more useful in ensuring all residents have access to the trail system as well as reinforcing the positive benefits trails provide to the community.



APPENDIX

FIGURE 7.1
2016 Trail System Map

THPRD TRAILS FUNCTIONAL PLAN

2016 Trail System Map

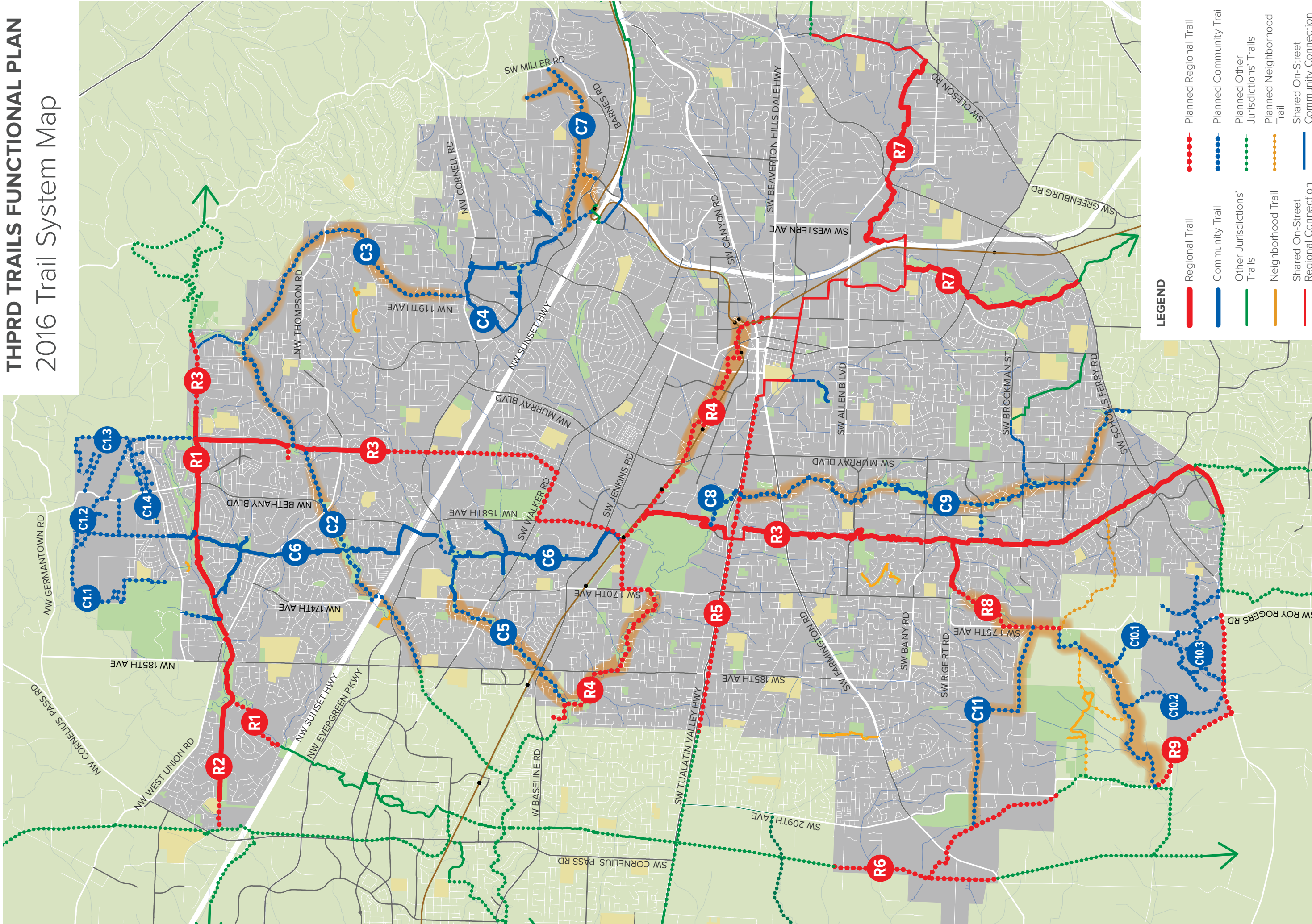

- REGIONAL TRAILS**
- R1** Rock Creek Trail
 - R2** Crescent Park Trail
 - R3** Westside Trail
 - R4** Beaverton Creek Trail
 - R5** Tualatin Valley Trail
 - R6** Reedville Trail
 - R7** Fanno Creek Trail
 - R8** McKernan Creek Trail
 - R9** South Cooper Loop Trail
- COMMUNITY TRAILS**
- C1.1** North Bethany Trail
 - C1.2** Bethany Creek Trail #1
 - C1.3** Bethany Creek Trail #2
 - C1.4** Bethany Creek Trail #3
 - C2** Bronson Creek Trail
 - C3** Bonny Slope West Trail
 - C4** Cedar Mill Creek Trail
 - C6** Waterhouse Trail
 - C7** North Johnson Creek Trail
 - C8** Beaverton Wetlands Trail
 - C9** South Johnson Creek Trail
 - C10.1** South Cooper Mt. Trail #1
 - C10.2** South Cooper Mt. Trail #2
 - C10.3** South Cooper Mt. Trail #3

LEGEND

- Regional Trail
- Community Trail
- Other Jurisdictions' Trails
- Neighborhood Trail
- Shared On-Street Regional Connection
- Shared On-Street Community Connection
- Bike Lane
- Trail Study Area Alignment TBD
- Future and Current Park District Boundary
- Planned Regional Trail
- Planned Community Trail
- Planned Other Jurisdictions' Trails
- Planned Neighborhood Trail
- Shared On-Street Community Connection
- MAX/WES
- Schools
- Parks

N

0 0.5 1 MILES

Map Created July 16, 2015

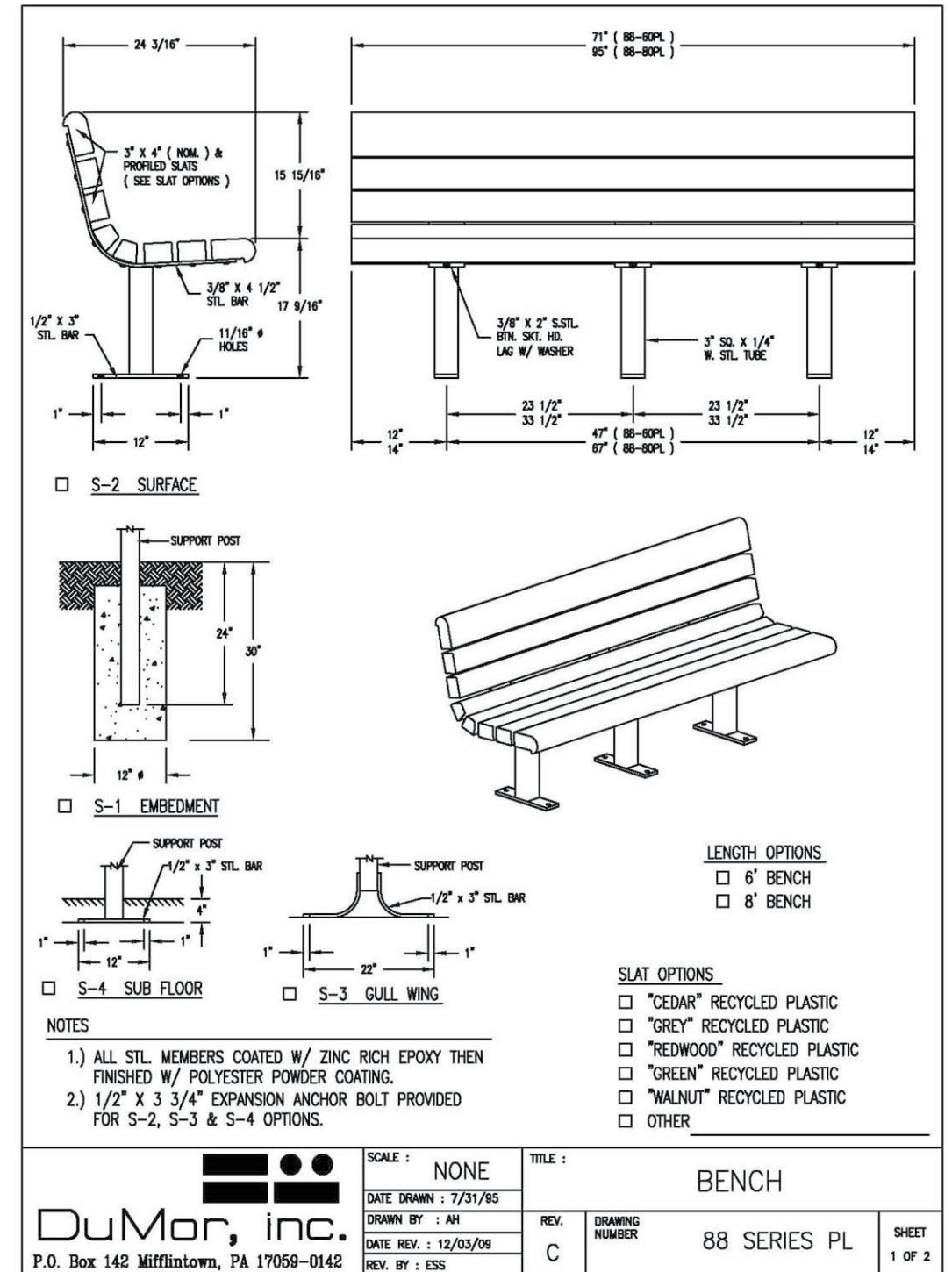

FIGURE 7.2.1A SITE FURNISHINGS
 Bench - Dumor 88-PL Series

7.2 TRAIL DETAILS

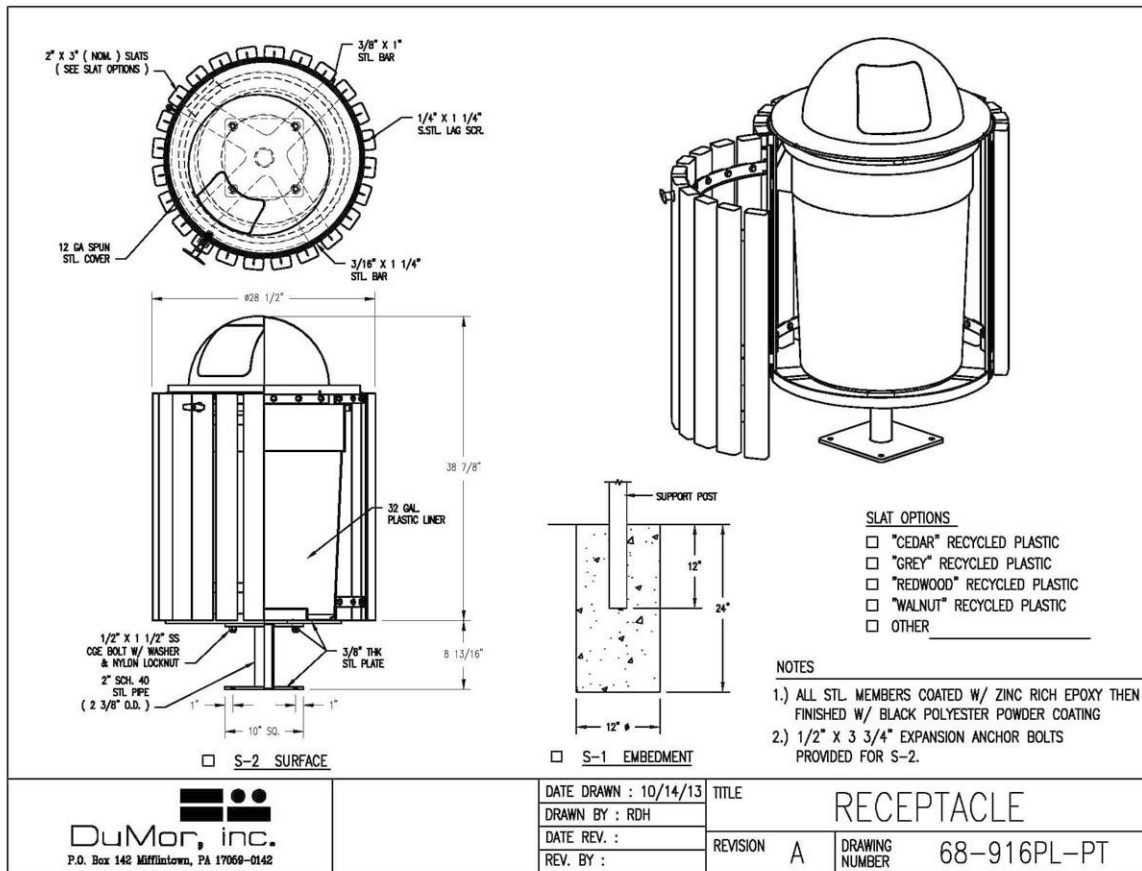

FIGURE 7.2.1B SITE FURNISHINGS
Trash Receptacle - Dumor 68-916PL-PT Series

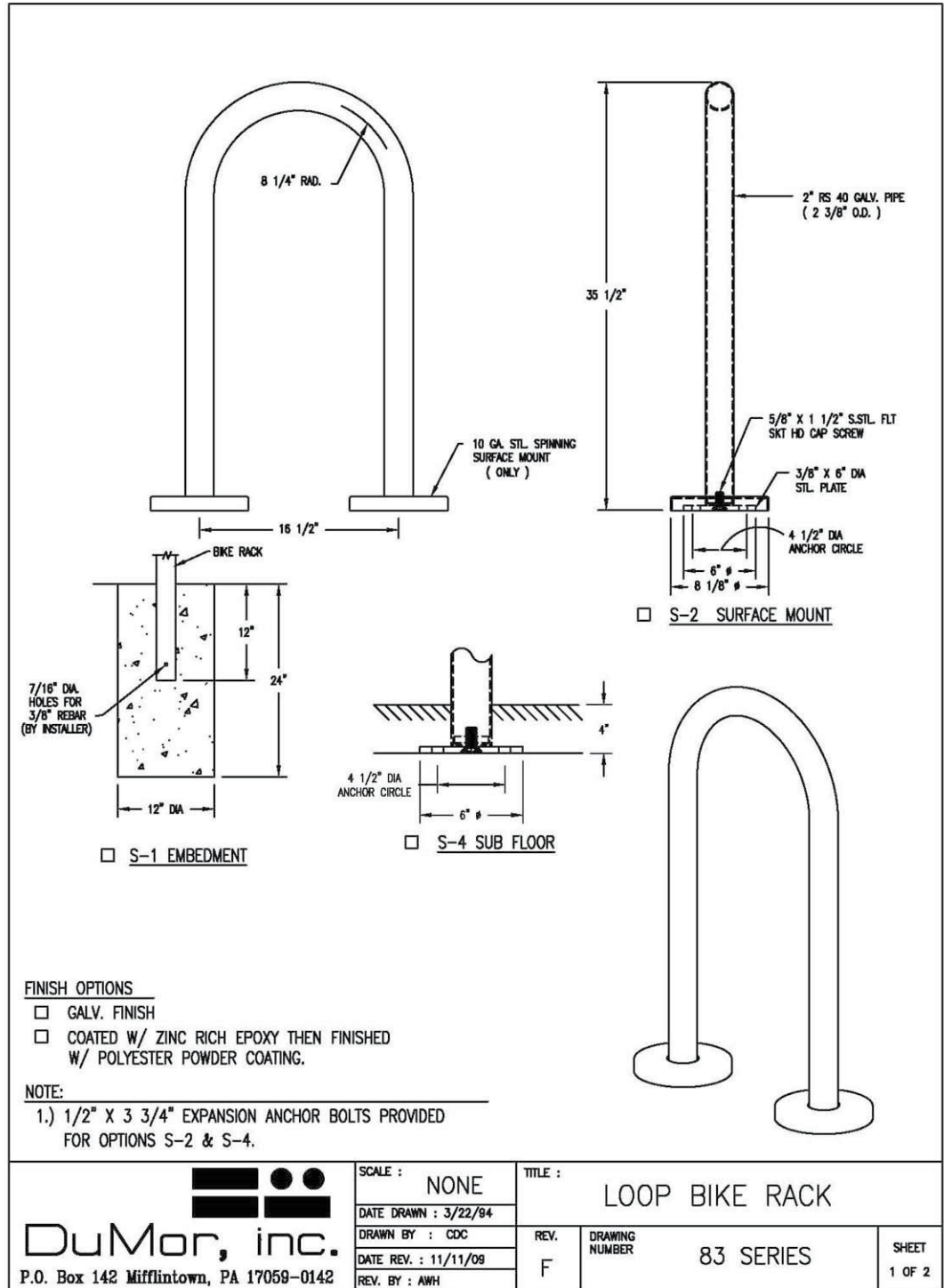

FIGURE 7.2.1C SITE FURNISHINGS
 Bike Rack - Dumor 83 Series

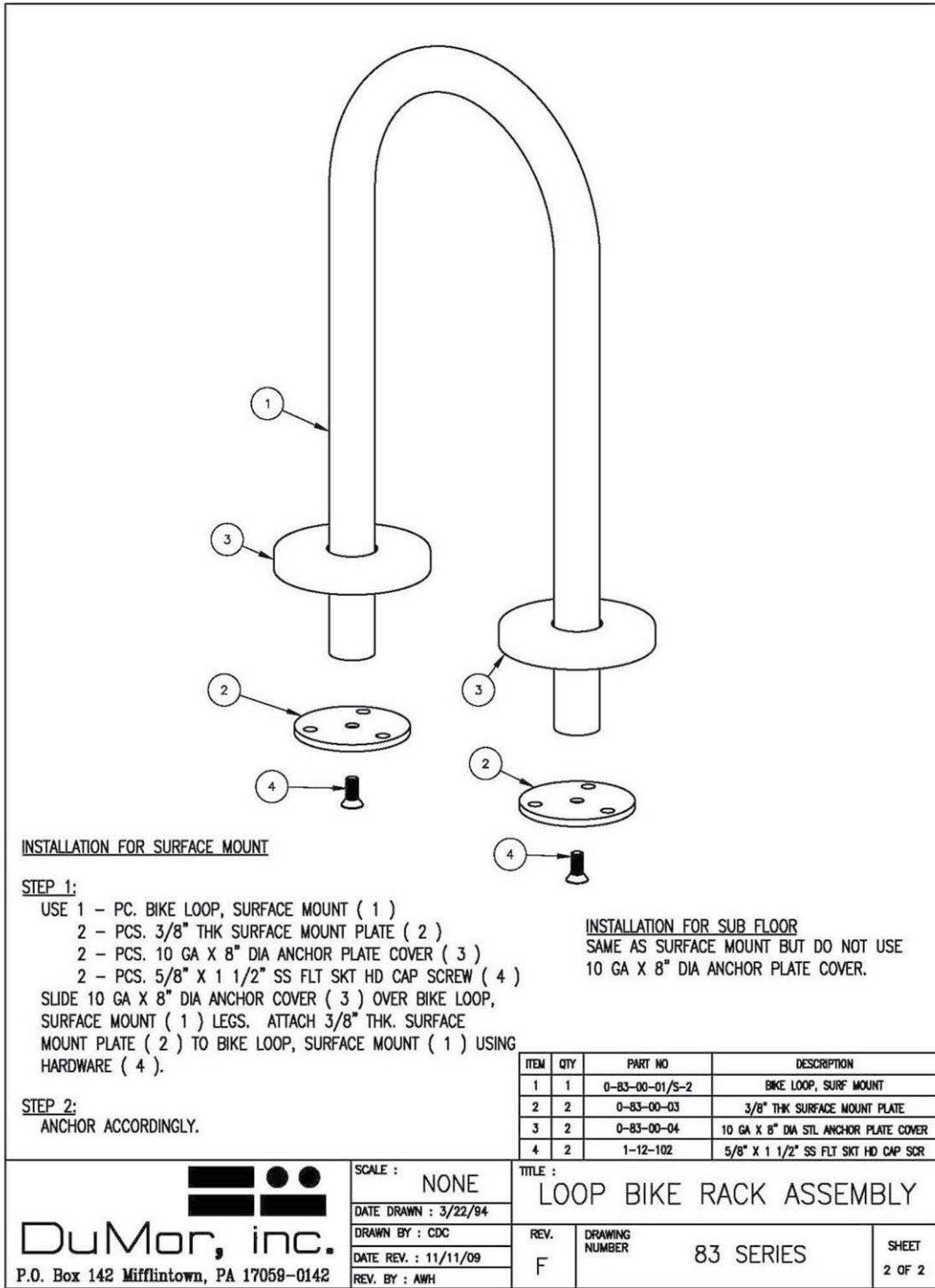

FIGURE 7.2.1D SITE FURNISHINGS
 Bike Rack – Dumor 83 Series (continued)

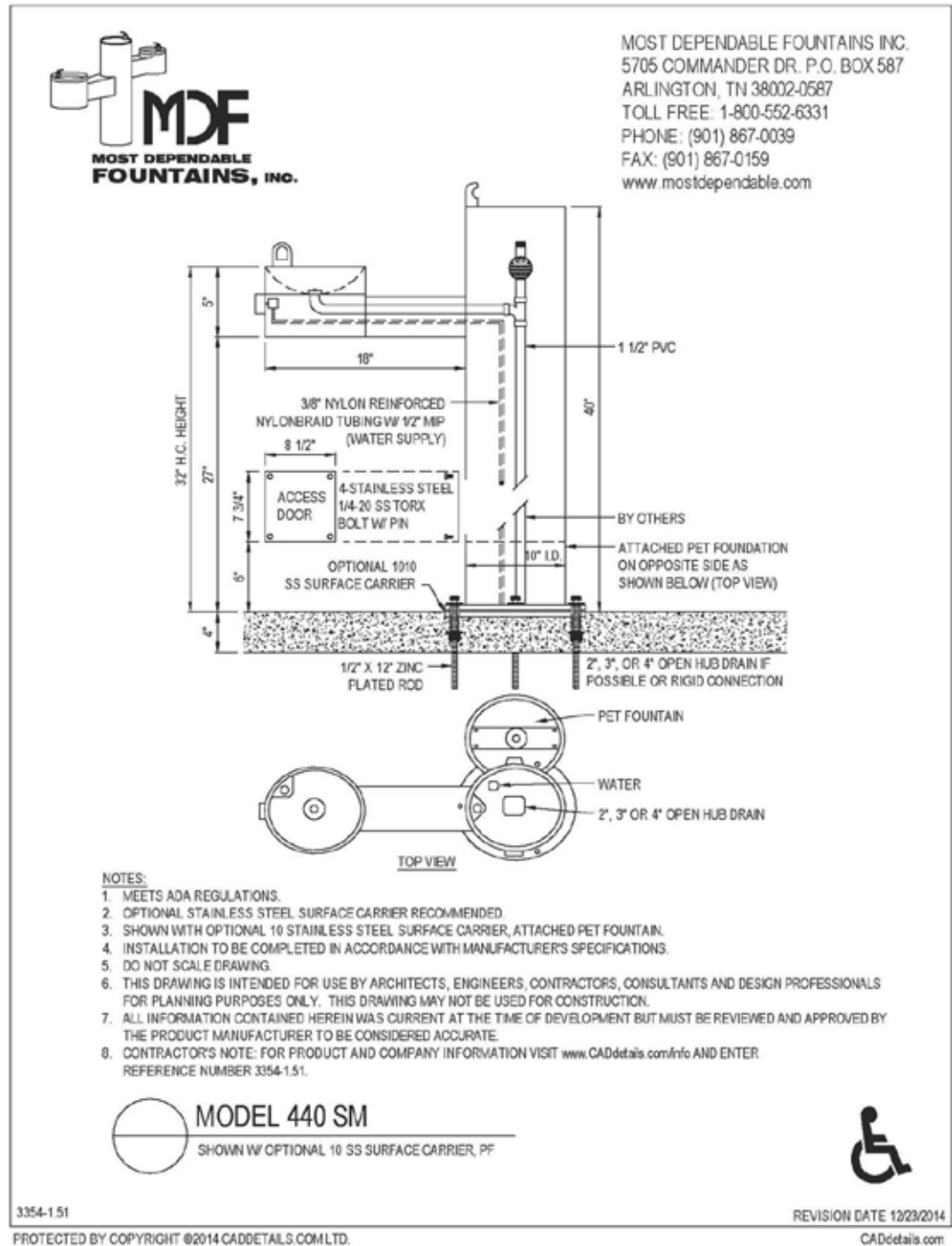

FIGURE 7.2.1E SITE FURNISHINGS
Drinking Fountain – Most Dependable Fountain 440 SM

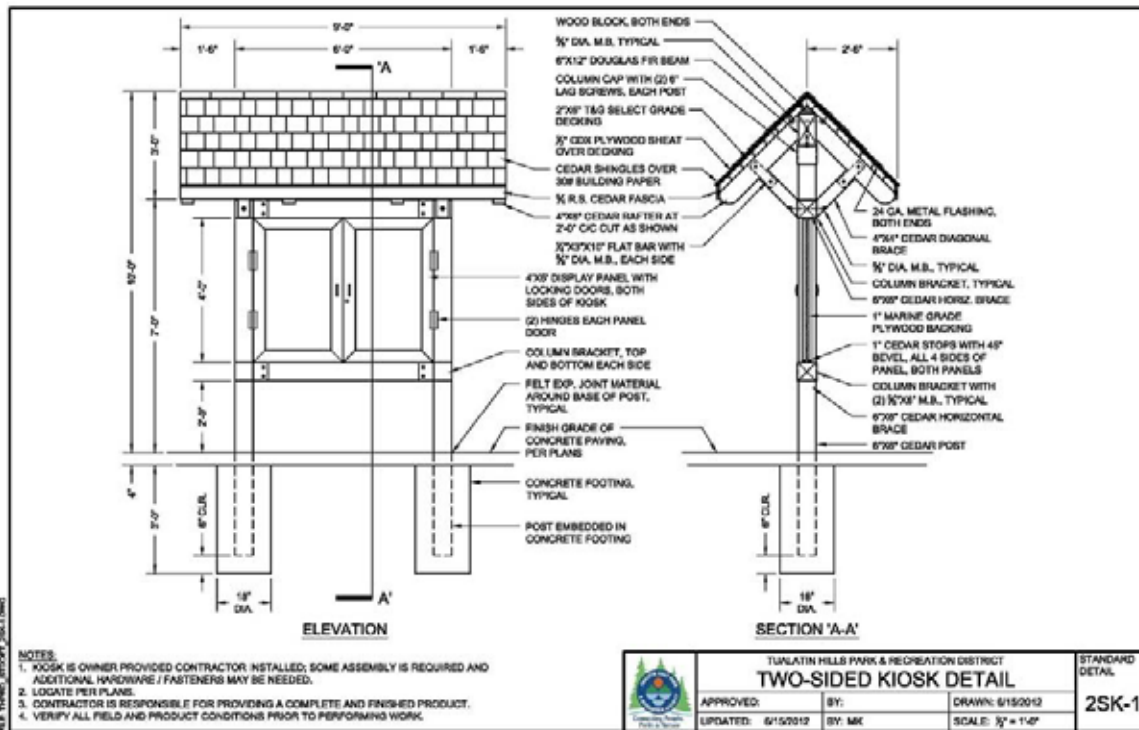

FIGURE 7.2.1F SITE FURNISHINGS
 Kiosk - THPRD standard

7.2.2 Bollards

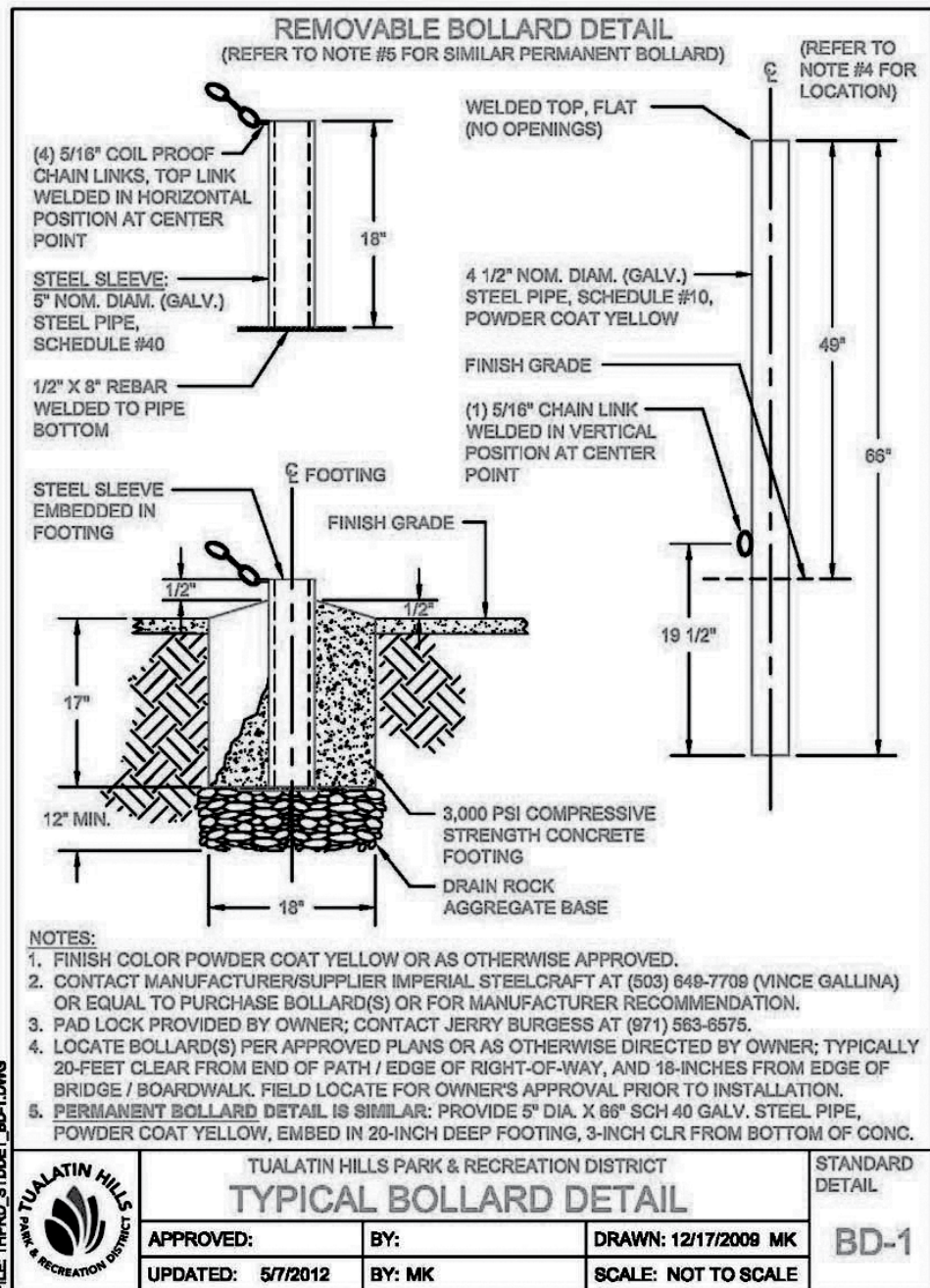

FIGURE 7.2.2 BOLLARDS

Permanent and Removable Bollard – THPRD standard

7.2.3 Signage

Type A Sign Family: Site Identification

These signs identify a site such as a park or athletic center for pedestrian and vehicular traffic. The type of sign used should be determined by the scale of the facility or facility entrance to be identified and the sign visibility conditions.

Type A1 provides identification for neighborhood parks or secondary entrances of larger facilities and is considered to be the "Standard" sign for the District.

Type A2 offers greater legibility for use in identifying larger parks or locations where traffic is typically above 35 mph. Parks with multiple entry points may use this type to indicate the primary entrance.

Type A3 provides identification at secondary and tertiary entrances or for smaller facilities such as a neighborhood park that does not require vehicular traffic visibility. This sign is typically paired with the park regulations sign panel.

Type A4 is for the identification of major facilities such as a large recreation complex.

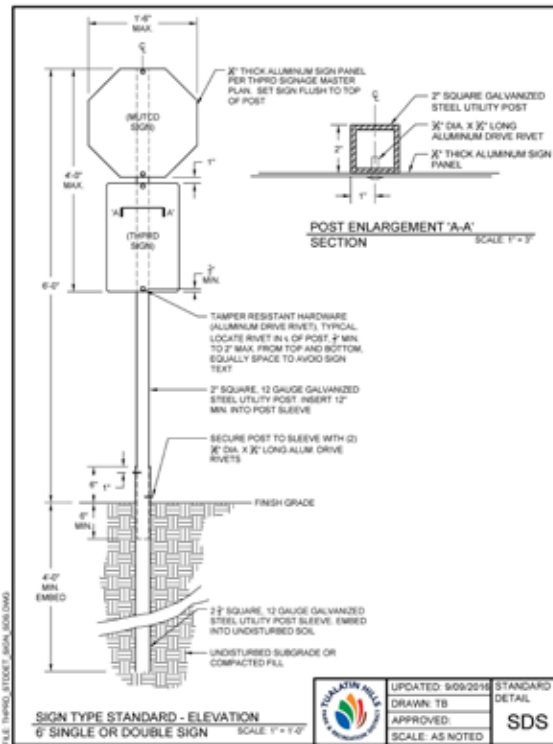
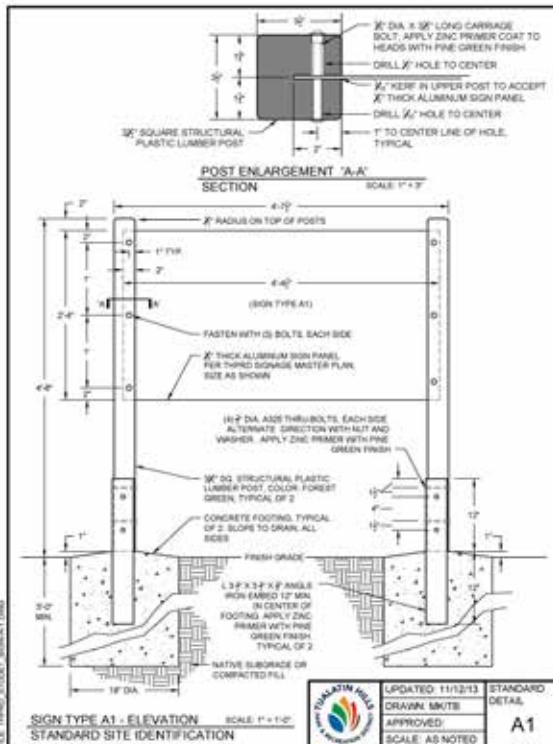

FIGURE 7.2.3A SIGNAGE
Type A Sign Family – Site Identification

Type D Sign Family: Trailhead Identification

These signs identify a trailhead.

Type D1 provides trailhead identification and rules without additional information.

Type D2 has a map included (with horizontal and vertical versions).

Optional directional panels can be applied to any of these.



Type D1 - Trailhead Identification (Small)

Type D2 - Trailhead Identification with Map

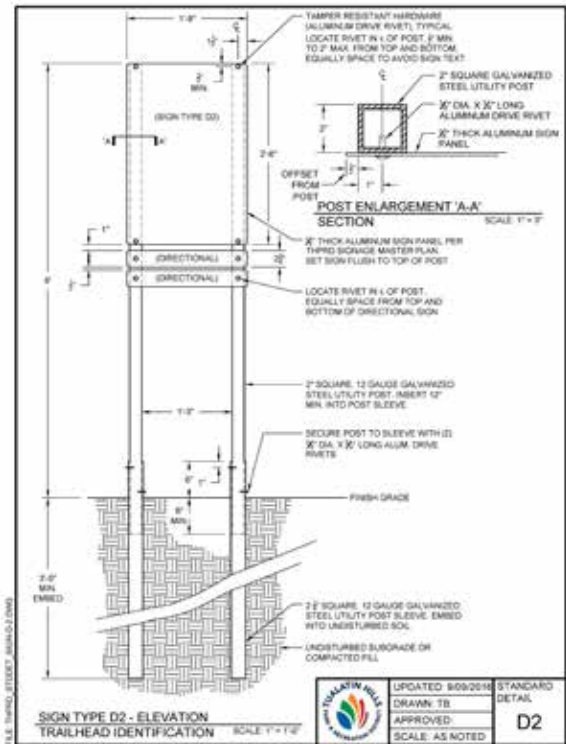
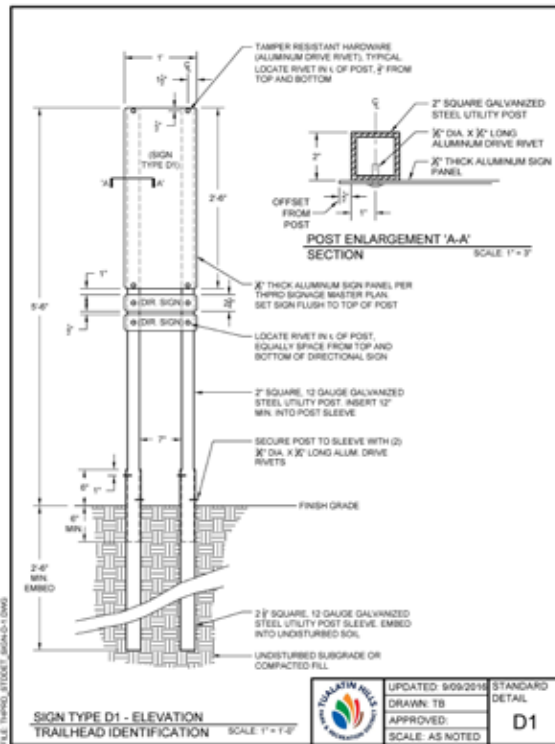

FIGURE 7.2.3D SIGNAGE
Type D Sign Family – Trailhead Identification

Type R Sign Family: Regulatory Signs

These signs provide rules and regulations.

Type R1 provides park/trail rules and is typically located at pedestrian entries to the park. It uses an angle post while the other Type R signs use utility posts.

Type R2 provides disc golf rules.

Type R3 provides rules for the children's play area.

Type R4 provides dog park rules.

Type R5 provides basketball rules.

Type R6 provides hockey rules.

Type R7 provides skate park rules.

Type R8 provides tennis rules.

Type R9 provides synthetic turf rules.

Type R10 provides BMX track rules.

Type R11 provides Community Garden rules.



Type R5
Basketball Rules



Type R6
Hockey Rules



Type R7
Skate Park Rules



Type R10
BMX Track Rules



Type R11
Community Garden Rules

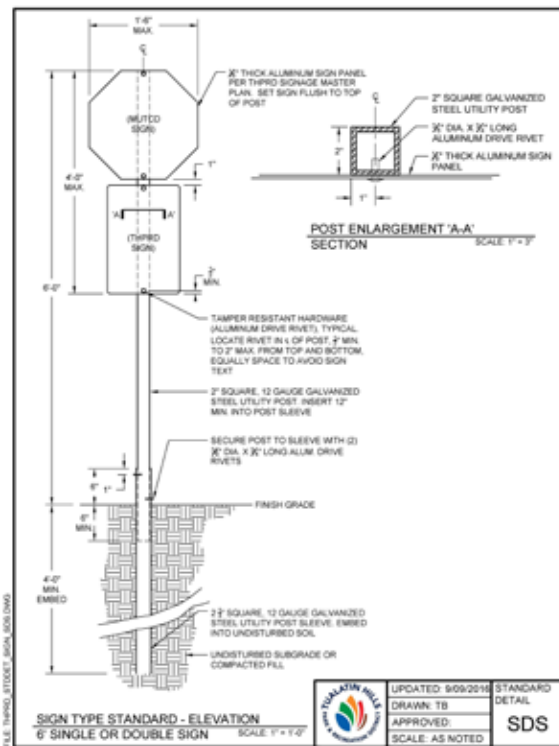

FIGURE 7.2.3R SIGNAGE
Type R Sign Family – Regulatory

Type T Sign Family: Directional and Safety Signs

These signs provide direction for pedestrians and vehicles.

Type T1 provides trail identification and direction.

Type T2 indicates mileage distance on trails.

Type T3 alerts with direction of trail gaps to connect to the next trail segment.

Type T4 indicates the current location of major street crossings for user orientation.

Type T5 provides direction to major destinations for pedestrians.

Type T6 provides direction for pedestrians on a building wall.

Type T7 provides direction for vehicles.

Type T8 lists major destinations for vehicle traffic.

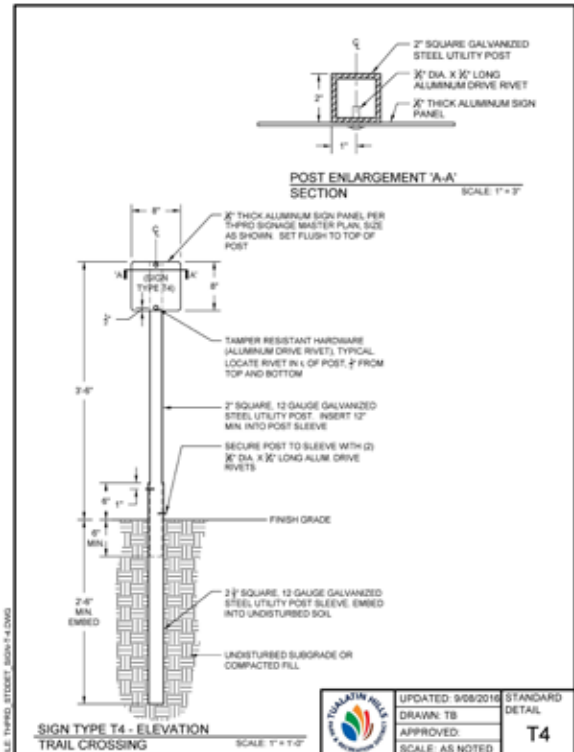
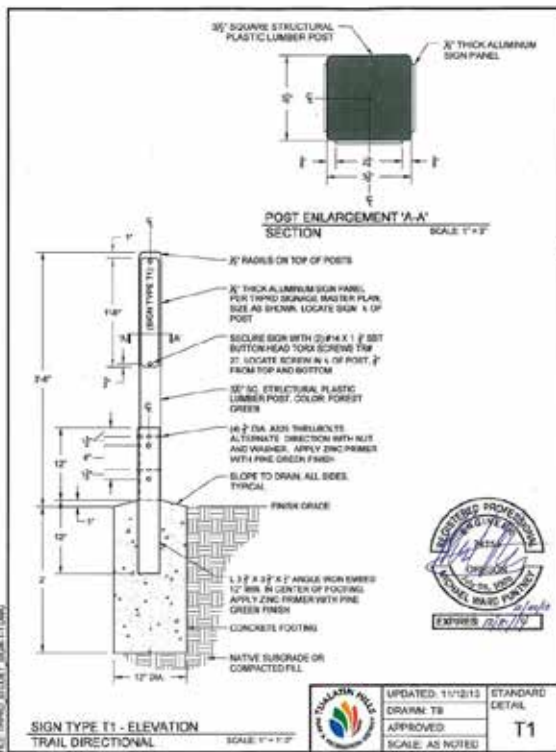
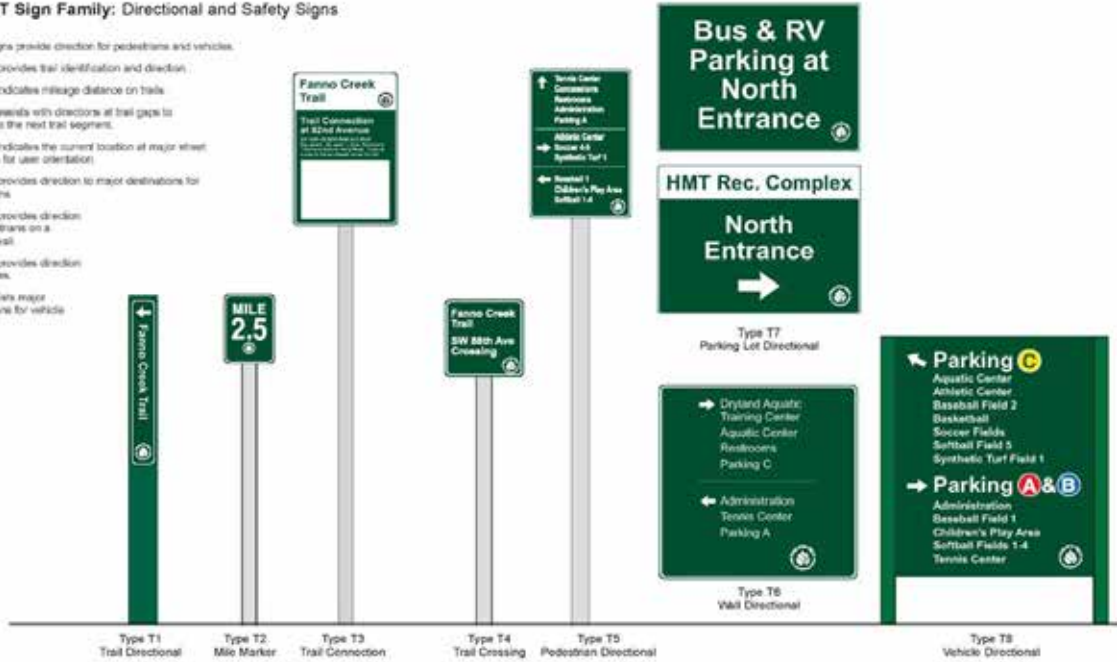

FIGURE 7.2.3T SIGNAGE
Type T Sign Family – Directional and Safety

7.2.4 FENCING

NOTE: FENCING MATERIAL SHALL BE 'JUMBO SPLIT RAIL' AS PROVIDED BY DICK'S EVERGREEN FENCE OR APPROVED EQUAL.

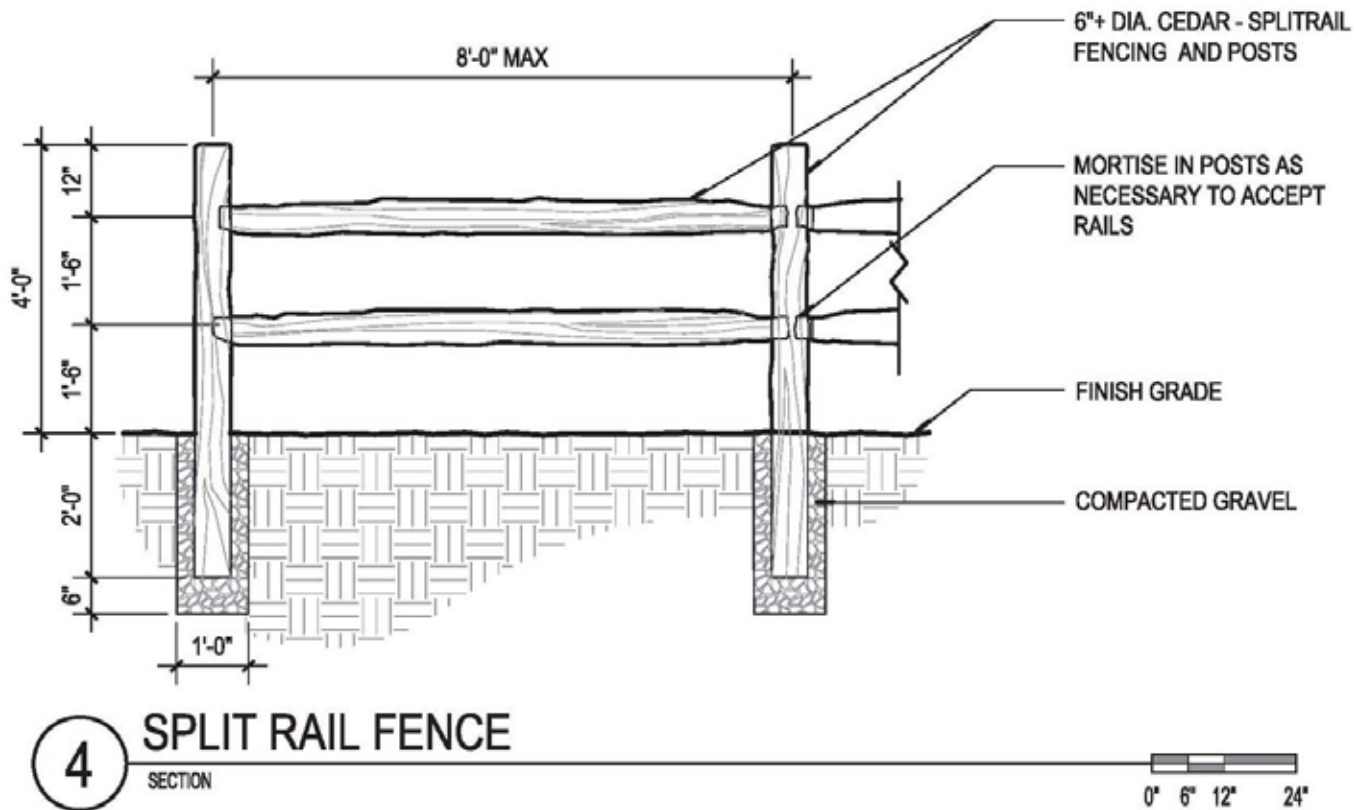

FIGURE 7.2.4 FENCING
Split-rail fence

7.3 TRAIL COUNTS 2010–2015

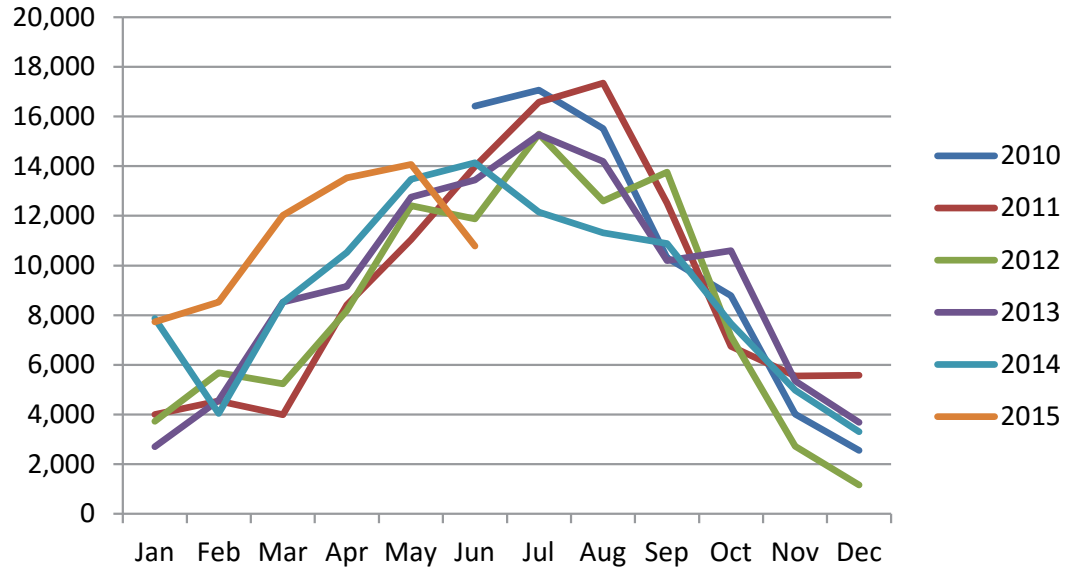

FIGURE 7.3.1A TRAIL COUNTS 2010-2015
Fanno Creek Regional Trail at SW Scholls Ferry Road

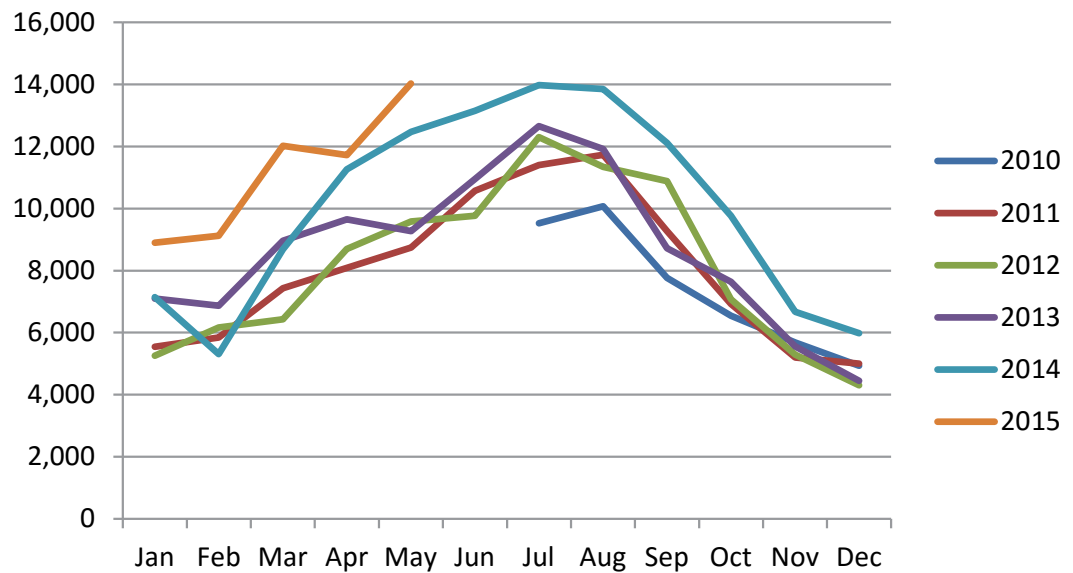

FIGURE 7.3.1B TRAIL COUNTS 2010-2015
Fanno Creek Regional Trail at SW Hall Boulevard

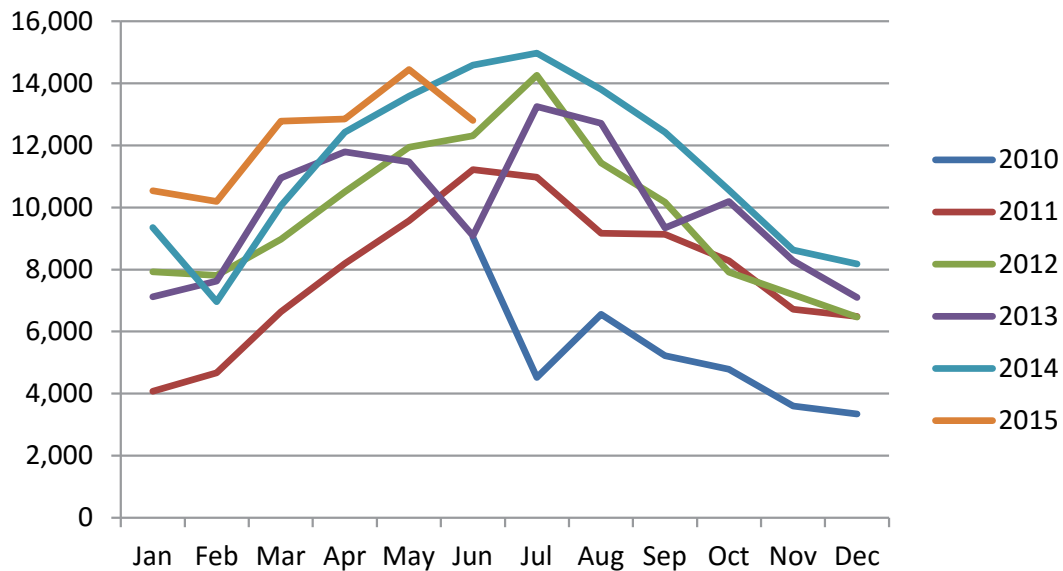

FIGURE 7.3.1C TRAIL COUNTS 2010-2015
Fanno Creek Regional Trail at SW 92nd Avenue

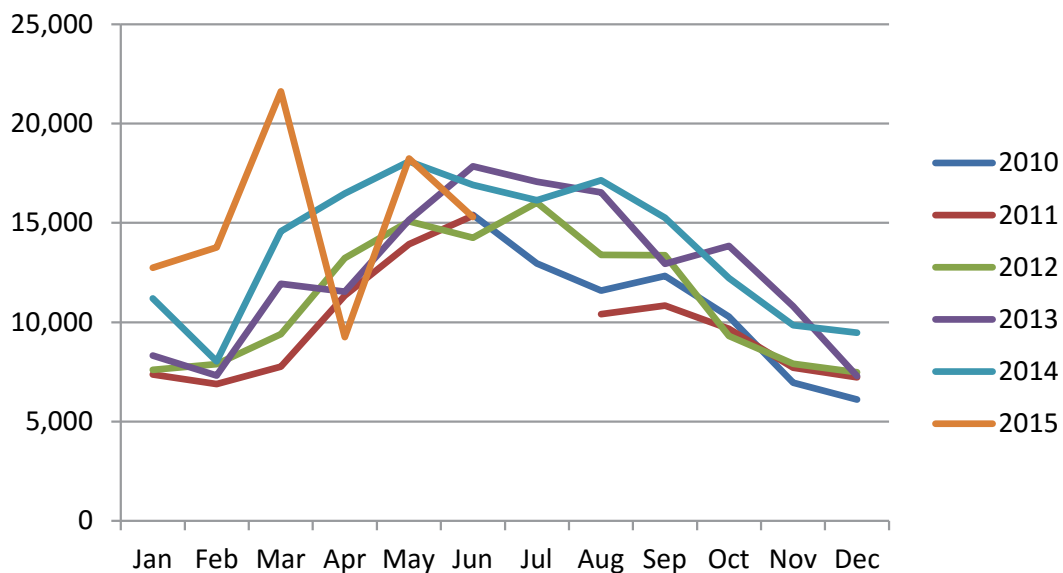

FIGURE 7.3.2 TRAIL COUNTS 2010-2015
Rock Creek Regional Trail at Pirate Park/Waterhouse Trail

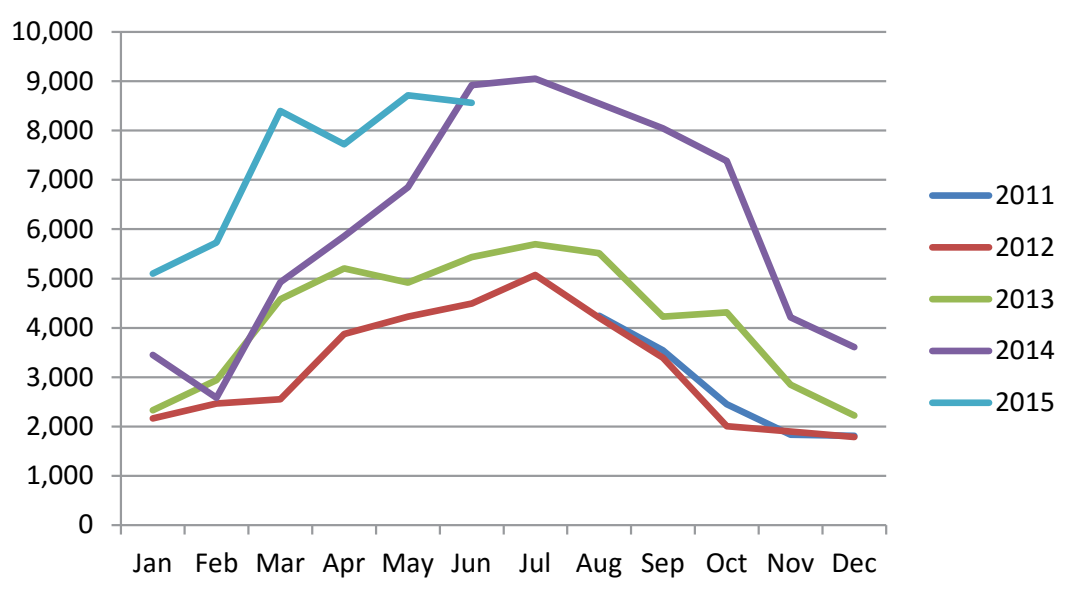

FIGURE 7.3.3A TRAIL COUNTS 2010-2015
Waterhouse Community Trail at SW Walker Road (north side)

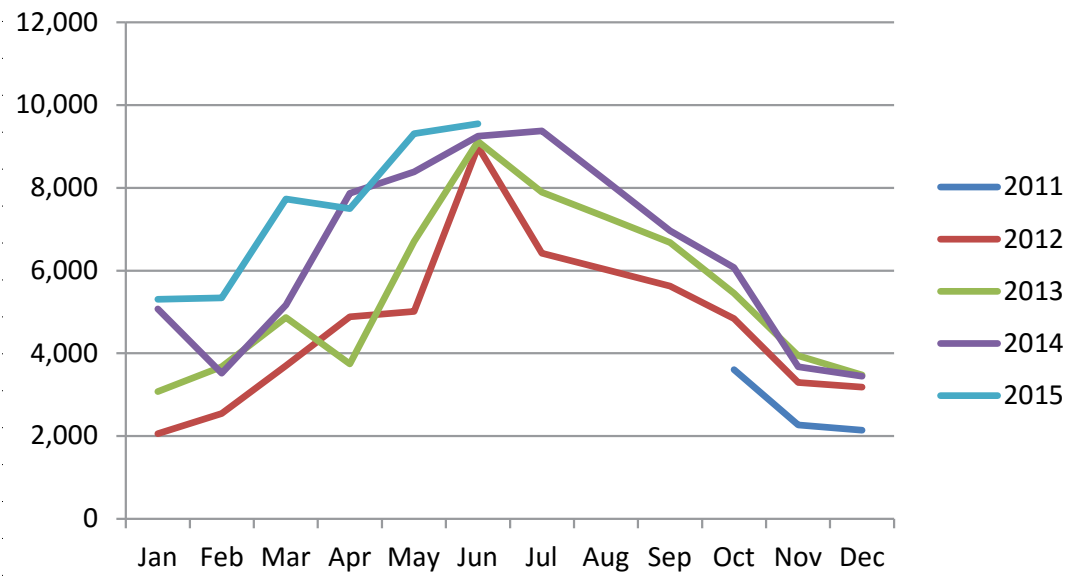

FIGURE 7.3.3B TRAIL COUNTS 2010-2015
Waterhouse Community Trail at SW Walker Road (south side)

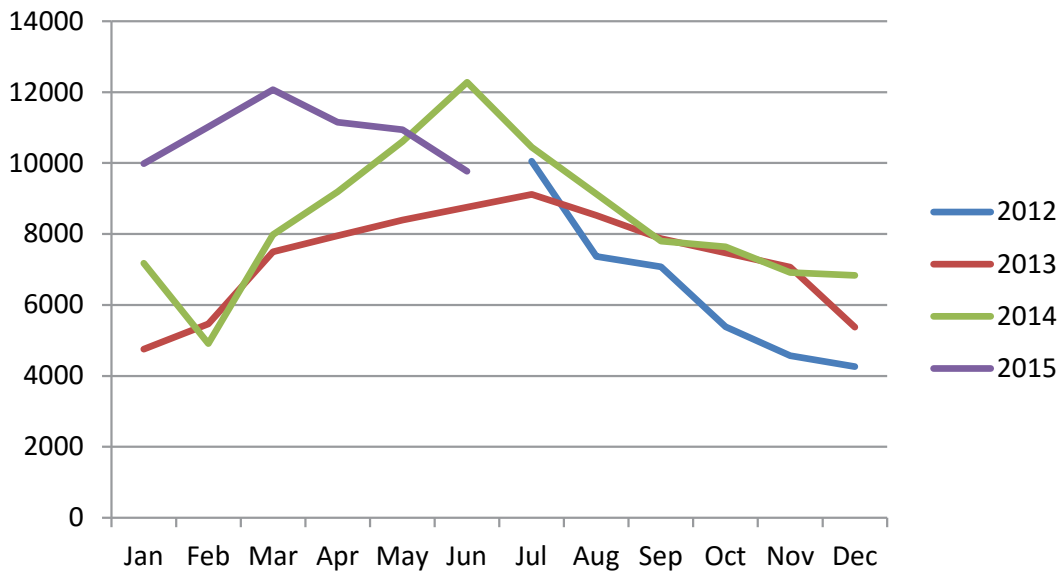

FIGURE 7.3.4A TRAIL COUNTS 2010-2015
Westside Regional Trail at SW Village Lane

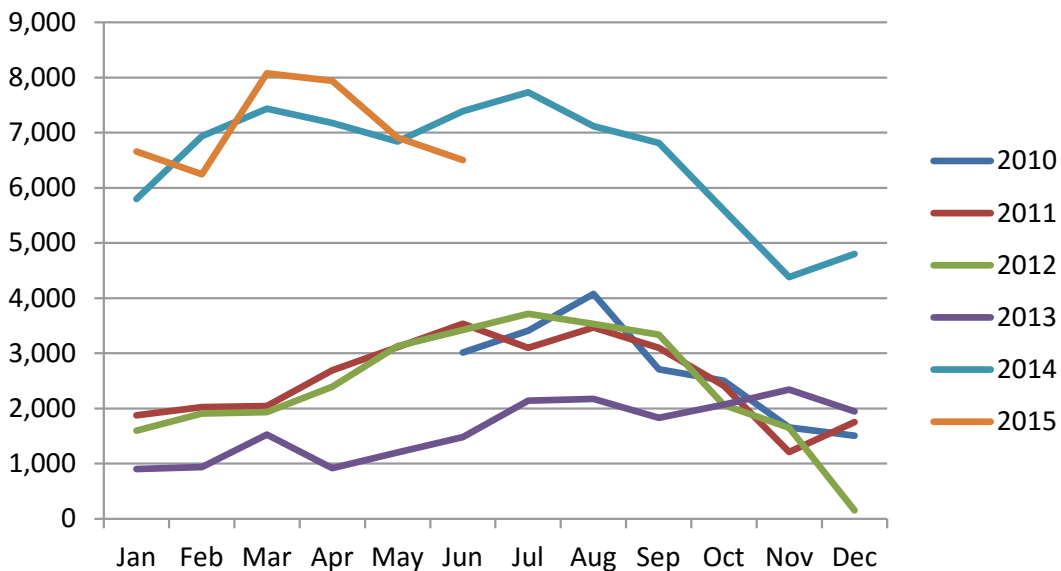

FIGURE 7.3.4B TRAIL COUNTS 2010-2015
Westside Regional Trail at Murrayhill Park

